

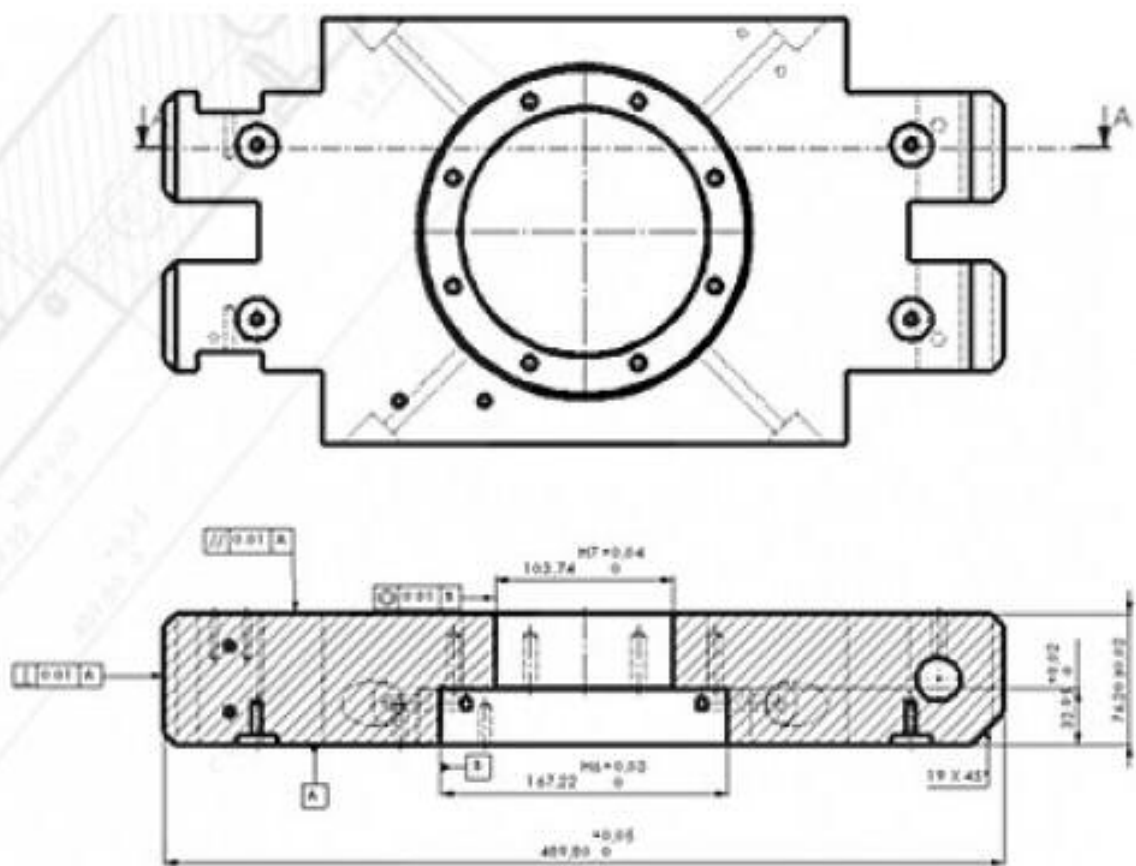

<b>MERCEDES</b>	<b>4</b>
<b>VOLKSWAGEN-AUDI-SKODA-SEAT</b>	<b>12</b>
<b>OPEL</b>	<b>36</b>
<b>BMW</b>	<b>45</b>
<b>RENAULT</b>	<b>54</b>
<b>PEUGEOT/CITROËN</b>	<b>61</b>
<b>FORD</b>	<b>64</b>
<b>FIAT, ALFA, LANCIA</b>	<b>67</b>
<b>UNIVERSAL TOOL</b>	<b>84</b>
<b>TRUCKS</b>	<b>100</b>





## 4M-360 SA

*Brand:* Mercedes  
*Product Code:* 4M-360 SA

Specifically designed for the Mercedes vehicles fitted with the chain driven 1.8/2.1 CDI Diesel Engines (engine code pre fix 651.xxx).

These engines are found across the Mercedes range including A, B, C,

E, G and S class as well as the Sprinter and Vito vans from as early as 2007 up to 2015.

*Components:*  
Camshaft Locking Tool (2),  
*OEM Ref:* 651 589 01 40 00  
Crankshaft Pulley Holding Tool,  
*OEM Ref:* 651 589 00 40 00



## 4M-065

*Brand:* Mercedes  
*Product Code:* 4M-065  
*OEM Tool Code:*  
601 589 05 21 00

Special locking nut for diesel injection pump camshaft. M18x1.5 metric threads.

Engine OM601, OM602, OM603, OM605, OM606, OM617.  
Same as OEM 601 589 05 21 00



## 4M-142.2

*Brand:* Mercedes  
*Product Code:* 4M-142.2

Diesel Injector  
Seat Cutter-Mercedes-Renault-PSA



## 4M-360.3

*Brand:* Mercedes  
*Product Code:* 4M-360.3  
*OEM Tool Code:*  
651 589 02 63 00

Mercedes M651 CDI Chain Engine  
Camshaft Locking Crank Holding  
Timing Tools 651 589 02 63 00



## 4M-096.2

*Brand:* Mercedes  
*Product Code:* 4M-096.2  
*OEM Tool Code:* OM 647 CDI,

Injector Nozzle Puller for Mercedes Sprinter Diesel 2.7L CDI OM 647 CDI, OM611.



## 4M-142

*Brand:* Mercedes  
*Product Code:* 4M-142  
*OEM Tool Code:*

Diesel injectors seat cutter and face cleaner: a. after removing used injector from cylinder head is important to clean seat of injectors, by this tool you can. Clean seat as well as injector seat.  
b. all process is made manually

turning by hand with apply little bit of pressure.  
Contents: - suitable for Mercedes CDI; - for cleaning nozzle seating area and nozzle chamber before changing and replacing the injection nozzle or if nozzle has a leak; - turn manually and apply soft pressure for clean fit of the cylinder head and the nozzle and for cleaning the nozzle chamber



## 4M-107

*Brand:* Mercedes, Renault  
*Product Code:* 4M-107  
*OEM ref:* MOT1520

Positioning pin for Lucas distributor Injection pumps Diesel MOT 1520 Renault Mercedes OM604 MOT1520



## 4M-028

*Brand:* Mercedes  
*Product Code:* 4M-028  
*OEM Tool Code:*  
001 589 65 09 00

Special 1/2" drive socket with 33 teeth for removing and mounting the pressure valve holder on the injection pump of Mercedes-Benz diesel passenger cars 601, 602, 603, 605, 606, 615, 616, 617. Made by (MMMM) Brand from Europe. Similar to Factory Tool and similar to the HAZET 4556 tool.



## 4M-359

Brand: Mercedes  
Product Code: 4M-359  
OEM Tool Code: 271 589 01 40 00

Chain timing / placing / holding  
retainer tool Mercedes 271-engine



## 4M-012

Brand: Mercedes  
Product Code: 4M-012  
OEM Tool Code: 116 589 04 6

Upper wheel ball-joint installation  
tool, for Mercedes: W116,  
W123, W126.



## 4M-360.4

Brand: Mercedes  
Product Code: 4M-360.4  
Universal product code:  
651 589 09 4

Camshafts locking tool  
Mercedes 651  
OEM CODE: OEM - 651 589 09 40 00



## 4M-312

Brand: Mercedes  
Product Code: 4M-312  
OEM Tool Code:

Mercedes glow plugs replacement  
tool M8 Mercedes A and B class  
W212



## 4M-096.15

Brand: Mercedes  
Product Code: 4M-096.15

Diesel injector extractor tool Mercedes CDI 651



## 4M-001

Brand: Mercedes  
Product Code: 4M-001  
OEM Tool Code: 924-589-0231-00

Springs removal and installation tool, for Mercedes: W116, W123, W124, W126, W129, W140, W170, W201 W202, W210, etc.



## 4M-002

Brand: Mercedes  
Product Code: 4M-002

Special designed for removing and installing the ball joint on car without removing any parts.

Applicable: Mercedes Benz W-124, W-129, W-201



## 4M-004

Brand: Mercedes  
Product Code: 4M-004

Bushing (silent block) Remover & Inserting Set Tool for Mercedes: W201, W124



## 4M-113

Brand: Mercedes  
Product Code: 4M-113  
OEM Tool Code:  
203589000700

Mercedes Benz 203 589 00 07 00  
Special 2 Pin Strut Socket C230  
C240 C280



## 4M-154

Brand: Mercedes  
Product Code: 4M-154  
OEM Tool Code:  
220-0343-M1229

Mercedes Benz Ball Joint Replacement Tool Kit 220-0343-M1229  
Application: W211, W215, W219, W220 and W230  
This is not cast metal tool. This is top quality one piece of metal machined tool  
Total weight is 6 kg ( 13 lbs).  
Madded to last !



## 4M-154.1

Brand: Mercedes  
Product Code: 4M-154.1

Mercedes upper Benz Ball Joint Replacement Tool Kit (to be used with 4M-154)

Application : Used to install the upperball joint into the steering knuckle on Mercedes 211, 215, 219, 220, and 230 chassis cars.



## 4M-142.5

Brand: Mercedes  
Product Code: 4M-142.5

Diesel Injector  
Seat Cutter-Mercedes-Piezo





## 4M-366

Brand: Mercedes  
Product Code: 4M-366  
OEM Ref:  
164 589 01 07 00

Fuel Delivery Slotted Wrench for lock ring on fuel pump/sending unit. Massive 190mm outside diameter, 22 fingers, 1/2" drive. For M-Class W164 from 2005-2011. And R-Class W251 Chassis. Aftermarket Tool at a much better price than a factory tool.



## 4M-008

Brand: Mercedes  
Product Code: 4M-008

Mercedes Diesel Pre-Chamber Ring Socket OM615 OM616 OM617



## 4M-009

Brand: Mercedes  
Product Code: 4M-009  
OEM Ref: 604-589-01-09-00

Mercedes Benz Diesel PRE-Chamber Retainer Ring Socket (58 TEETH)



## 4M-029

Brand: Mercedes  
Product Code: 4M-029  
Mercedes Benz R170, W124, W201, W202, W208 Rear axle bearing tool for changing the front and rear silent blocs on the rear axle.

4M-029 is comparable to OEM number  
140589033300  
140589043300  
140589053300  
140589123300



## 4M-043.2

Brand: Mercedes  
Product Code: 4M-043.2

Truck Injector Nozzle Socket  
Mercedes / MAN.



## 4M-096

Brand: Mercedes  
Product Code: 4M-096

Injector Nozzle Puller with claw and Slide Hammer. For injector nozzles that do not fit very tightly. Mercedes Sprinter 5 Cylinder Diesel 2.7L, CDI OM611, OM612, OM613, OM646\*, OM647, OM648.

\*NOT OM646 EVO.



## 4M-070

Brand: Mercedes  
Product Code: 4M-070  
Heavy duty-FULL STEEL- Oil Filter Socket - 14-Point, 74.4mm - MANN, KNECHT i VAUXHALL Longlife. MERCEDES-BENZ 2.2 l CDI motorom, M 102, M 103, M 104, M 110, M 111, M 119, M 120, M 613, Sprinter 2.2 l Turbo 2006. VW-Audi-Skoda -Seat

BMW passenger cars, BMW bike K-modeli = K 75-1100 LT, F i K VW Passat 1.9TDI injection, Passat B7 1.4 - 1.8 - 2.0 l TSI, Golf Plus 2.0 2005, Golf 6 1.6 l i 1.2/1.4/1.8/2.0 TSI, Golf 7 1.2 - 1.4 TFSI, Polo 5 1.2 l - 1.4 l TSI, Tiguan 2007 1.4 l TSI (110kW) 2.0 l TSI. FORD, VAUXHALL, PORSCHE, PEUGEOT, CITROËN, RENAULT, NISSAN, TOYOTA, MAZDA



## 4M-070.6

Brand: Mercedes  
Product Code: 4M-070.6

Heavy duty-FULL STEEL- Oil Filter Socket 84mm 14 point oil filter wrench fits many Mercedes, Dodge, & Jeep 3.0L diesel engines that use the cartridge style oil filter system. This wrench does not work on vehicles with traditional canister filters that you unscrew and throw away.



## 4M-154

*Brand:* Mercedes  
*Product Code:* 4M-154

Special designed for removing and installing the ball joint on car without removing any parts.  
*Applicable:* Mercedes Benz W220, W211, W230



## 4M-033.1

*Brand:* Mercedes  
*Product Code:* 4M-033.1

Universal Ball joint-Mercedes, BMW, VW-Audi



## 4M-311

*Brand:* Mercedes  
*Product Code:* 4M-311

Design to pull out the broken head glow plug on the engine.M10  
*Applicable:* Mercedes CDI engine OM 611, 612, 613, 646, 647 and 648 etc.

## 4M-048



*Brand:* Volkswagen - Audi  
*Product Code:* 4M-048  
*OEM Tool Code:* 3242 / T30052

*Engine Codes:*  
 •Audi: AAH, AFC, AHA, AKB, ART, ATQ, AUX, AWN, AYS, BBD, BCY, BEL, BFM, BHF, BNK, BSB  
 •Volkswagen: AHA, ATQ, BCY, BDP

This is the lock pin that is screwed into the front of the block that locks the crankshaft at top dead center to ensure proper alignment of the timing belt.

## 4M-310



*Brand:* Volkswagen - Audi  
*Product Code:* 4M-310  
*OEM Ref:* T10134

Passat 2006; Passat CC 2009; Sharan 1996; Touran 2003; Audi A2 2001; Audi A3 2004; Audi A4 2001; Audi A4 2008; Audi Q5 2008; Audi A6 2005; Caddy 2004; Audi A3 2004; Transporter 2004. Removes and installs. Seal housing carries the crankshaft sensor mounting.

Assembly Tool Number 4M-310 (OEM Tool code T10134) for setting the sealing flange on engines with integrated sender wheel.  
 Applicable for Audi A3 2004 and up, Touran 2004 and up, Sagitar 1.4TSI, Golf 2004, Touran 2004, Audi A3 2004, 4-cyl. diesel engine(4-valve), and 4 cylinder diesel engine applications including 2004 models 1.4i Turbo, 1.4-1.6-1.8-2.0 Direct Injection (Petrol), 1.9, 2.0SDI, 2.0 TDi, 2.0 and 2.0 Common Rails (Diesel), Golf 2004/Jetta 2006; Golf Plus 2005; Tiguan 2008; Eos 2006;

## 4M-155



*Brand:* Volkswagen - Audi  
*Product Code:* 4M-155  
*OEM ref:* T10100

- VAG 2.0Litre TDi PD DOHC and common engines fits Audi A3/A4/A5/A6 Skoda Octavia II Volkswagen Golf Jetta Touran

- Two versions of Sprocket Locking Tool Type A for bored (T10050) Type B for non-bored (T10100).  
 - Specifically designed for Belt driven diesel engines.  
 - Also found on the Ford Galaxy models with ASZ and ASZ1 VAG engines.



## 4M-115

*Brand:* Volkswagen - Audi  
*Product Code:* 4M-115  
*OEM Ref:* T10490

A comprehensive tool for the removal and fitting of the cambelt on popular 1.4, 1.6 and 2.0 VAG diesel engines fitted across the range. Also includes 2 pins for the gears in the cylinder head.

*Applications:* Audi A3 III, A4, Seat Leon III, Volkswagen Golf VII and Skoda Octavia 2012-2016 with engine codes: 1.4 CUSA, CUSB, CUTA and 2.0 CKFC, CKFB, CRBC, CRBD, CRFA, CRFC, CRLB, CRLC, CRMB, CRVA, CRVC, CSUA, CSUB, CUNA, CUPA



## 4M-025.3

*Brand:* Volkswagen - Audi  
*Product Code:* 4M-025.3  
*OEM Tool Code:* 3458

Camshaft locking or positioning tool, for VW, Audi. (2.5 TDI V6 engine)



## 4M-025.5

*Brand:* Volkswagen - Audi  
*Product Code:* 4M-025.5

Camshaft Alignment Locking Timing Tool-VW/Audi 5-cylinder 2.5 TDI Diesel engines; e.g. LT, T4



## 4M-072

*Brand:* Volkswagen - Audi  
*Product Code:* 4M-072

Bosch alternator pulley (with clutch) removal tool

## 4M-045.7



Brand: Volkswagen - Audi  
 Product Code: 4M-045.7  
 OEM Ref: T40133

Camshaft clamp used for securing Camshafts when adjusting timing  
 Applicable to: Audi: 2009-Newer A6 with 3.0L Supercharged V6 4v (CCAA) Q5 3.2L V6 4v (CALB) A5 3.2L V6 4v (CALA)

## 4M-350.2



Brand: Volkswagen - Audi  
 Product Code: 4M-350.2  
 OEM Ref: T10355

CRANKSHAFT CRANK HOLDING LOCKING TOOL FOR VW VAG SEAT SKODA TFSi TSi  
 Used to hold the pulley still whilst loosening or tightening the pulley fixing bolt

Additional Information:  
 - Specially designed for TFSi/TSi 1.8 & 2.0lt petrol engines found in the VAG ranges  
 - Equivalent to OEM T10355  
 - Specially shaped & hardened pins help prevent the tool falling out when under load  
 - Covers engines from 2006 onwards  
 - Crankshaft pulley (Vibration Damper) Holding tool

## 4M-350.1



Brand: Volkswagen - Audi  
 Product Code: 4M-350.1  
 OEM Ref: T10352-1

Camshaft adjustment tool - double sided.

Additional Information  
 - Camshaft Control Valve Removal  
 Tools for use on TFSi and TSi petrol engines Used to remove the Camshaft control valves prior to chain removal.

- Innovative double sided design.  
 - Equivalent to OEM T10352/1 & T10352.  
 - Application Audi: 3/A4/A5/Q5/TT, Seat/Skoda Octavia/Superb/Yeti Volkswagen: Golf/Jetta/Passat/Scirocco/Sharan/Tiguan with engine codes: CCZA, CCZB, CCZD, CDAA.

## 4M-025.2



Brand: Volkswagen - Audi  
 Product Code: 4M-025.2  
 OEM Ref: VAG 3418

VW GOLF SEAT AUDI 64.2 oz Diesel Locking Camshaft VAG 3418  
 EAN 3409340935879  
 Application : VW, Audi (engine 1.9D, 1.9TD, 1.9SD, 1.9SDI, 1.9TDI, Audi A3, VW Golf IV, etc.)



## 4M-025.1

Brand: Volkswagen - Audi  
Product Code: 4M-025.1  
OEM Ref: VAG-2065A

VAG 2065A Locking Plate Tool for VW AUDI Volkswagen Timing For blocking the camshaft and the pin gauge for the injection pump during changing the distribution belt for VAG Diesel engines.  
FOR VW vehicles : Caddy, Golf, Jetta, LT, Lupo, Passat, Polo, Santana,

Sharan, Transporter, Vento  
Types of engines : 1.3 / 1.4 / 1.6 / 1.7 / 1.9 / 2.4TDi  
Engines codes : 1G, 1S, 1V, 1W, 1X, 1Y, 1Z, AHU,AAB, AAZ, ABL, ACL, AEY, AFN, AGD,AHB, AHG, AHH, AHU, AJA, AKU, AKW, ALE, ASX, AVG, CR, CS, CY, DV, DW, JK, JP, JR, JX, KY, ME, RA, SB (1980-2005)  
For Audi, SEAT, Škoda vehicles



## 4M-110.1

Brand: Volkswagen - Audi  
Product Code: 4M-110.1  
OEM Ref: T10075

Camshaft locking tool T10075 - locating flange  
Application: VW Polo, Golf 1.4 16V and other petrol engines 16v  
Usage manual .



## 4M-110

Brand: Volkswagen - Audi  
Product Code: 4M-110  
OEM Ref: 10016  
OEM Ref: T10074

VW AUDI VAG TWIN CAM CAMSHAFT 1.4 & 1.6 16v CAM LOCKING TOOL T10016 / T10074  
Engine Codes: 1.4: AFK, AHW, AKQ, APE, AQQ, ARR, AUA, AUB, AXP, BBY, BBZ, BCA, BKY, BUD, BXW, CGGA, CGGB, CMAA 1.6: AJV, ARC, ATN, AUS, AVY, AZD, BAD, BCB



## 4M-092.1

Brand: Volkswagen - Audi  
Product Code: 4M-092.1  
OEM Ref: VW-3212

Double pin spanner same as VW number 3212. Adjustable wrench with 5mm diameter pins. Approximately 6" long. For the radiator fan. clutch / hydraulic

pump pulley on VW and Audi.  
NOTE: The fan coupling has reverse threads.  
Do force it in the wrong direction and risk breaking the pins on the tool! Please check your service manual for tool number 3212.

## 4M-165



*Brand:* VW-Audi-Seat-Skoda

*Product Code:* 4M-165

*OEM Ref:* 10171

For installing and removing the camshaft / variable camshaft to check and adjust the camshaft for timing. *Application:* Audi; A3 (03-10), Seat; Altea, Ibiza, Leon, Skoda; Fabia II (07-09), Octavia (04-09),

Roomster (06-09), Superb (09-10), VW; Eos (06-09), Golf (03-09), Golf Plus (05-09), Jetta (06-09), Passat (05-09), Polo (02-08), Scirocco (09-10), Tiguan (07-09), Touran (03-09) *Engine:* 1.4FSi (AXU, BKG, BLN) 1.4TFSi (BLG, BMY, BWK, CAVA, CAVB, CAVC,CAVD, CAVF, CAXA, CAXC, CDGA)1.6FSi (BAG, BLF, BLP, BTS)

## 4M-313.3



*Brand:* Volkswagen - Audi

*Product Code:* 4M-313.3

*OEM Tool Code:* T10195

VW Audi OEM Tool T10195

Crankshaft Locking Tool

## 4M-313.4



*Brand:* Volkswagen - Audi

*Product Code:* 4M-313.4

*OEM Tool Code:* T10199

BGS Motor adjustment tool Touareg Phaeton Tools 10 Cylinder Motor OEM T10199

- Suitable for Touareg and Phaeton from 2003 with 10-cylinder engines

- Clamping device for the removal and installation of the Camshaft sprocket with 10-cylinder engines, to use as OEM T 10199 / T 10199

## 4M-313.5



*Brand:* Volkswagen

*Product Code:* 4M-313.5

*OEM Tool Code:* T10199

BGS Motor adjustment tool Touareg Phaeton Tools 10 Cylinder Motor OEM T10199

- Suitable for Touareg and Phaeton from 2003 with 10-cylinder engines

- Clamping device for the removal and installation of the Camshaft sprocket with 10-cylinder engines, to use as OEM T 10199 / T 10199





## 4M-345.SA

*Brand:* Volkswagen - Audi  
*Product Code:* 4M-345.SA

Essential for the removal of the water pump.  
Also alignment of the engine at top dead centre.  
Specially for Volkswagen T5 & Touareg 2.5D.

It is beneficial to change the water pump when removing the cylinder head.

A - Special Wrench OEM ref T10225,  
B - Puller OEM ref T10221 A,  
C Adjusting Tool OEM ref T10222A.



## 4M-147

*Brand:* Volkswagen - Audi  
*Product Code:* 4M-147  
*OEM Tool Code:* T10120

VW T10120 Timing Chain Special  
Tool Engine Timing Tool Audi 3  
Cylinder

Locking the camshaft setting the timing with timing chain.

Suitable for:  
3 cylinder injection engine 1.2 l  
Engine Identification: AWY, BMD,  
BBM  
Audi & Volkswagen



## 4M-147.1

*Brand:* Volkswagen - Audi  
*Product Code:* 4M-147.1  
*OEM Tool Code:* T10123

T10123 Timing Chain Special Tool  
Engine Timing Tool Audi, VW, Polo,  
Škoda, 3 Cylinder, 12V

Locking the camshaft setting the timing with timing chain.

Suitable for:  
3 cylinder injection engine 1.2 l



## 4M-147.2

*Brand:* Volkswagen - Audi  
*Product Code:* 4M-147.2  
*OEM Tool Code:* T10121

T10121 VW Camshaft locking tool,  
VW Polo, Škoda Fabia, 1.2 - 3 cil.  
12V.

Locking the camshaft setting the timing with timing chain. Suitable for: 3 cylinder injection engine 1.2 l  
Engine Identification: AWY, BMD,  
BBM Audi & Volkswagen



## 4M-147.4

*Brand:* Volkswagen - Audi  
*Product Code:* 4M-147.4  
*OEM Tool Code:* T10414

Engine Locking tool VAG 1.2TSI/TFSI Petrol Engines T10414  
Engine locking kit - VAG 1.2TSI/TFSI petrol engines (2009-2016)  
Engine codes CBZA, CBZB, CBZC



## 4M-149

*Brand:* Volkswagen - Audi  
*Product Code:* 4M-149  
*OEM Tool Code:* 3297

Tensioning lever for tensioning alternators with poly V-belt VAG 3297



## 4M-155-1

*Brand:* Volkswagen - Audi  
*Product Code:* 4M-155-1  
*OEM Tool Code:* T10255

Diesel Engine Balance Shaft Locking Tool- VAG 2.0 Pumpe Duse - Belt Drive. Special tools required during removal/installation of the balance shaft on certain VAG 2.0

Pumpe Duse diesel engines. Set comprises balance shaft locking tool and chain tensioner locking pin. These engines are a belt drive with the balance shaft driven separately by a chain. OEM Tools: T10255  
Engine Codes: BLB, BNA, BRD, BRE, BRF, BVA, BVF, BVG



## 4M-131

*Brand:* Volkswagen - Audi  
*Product Code:* 4M-131  
*OEM Tool Code:* T10055

This specialist kit is designed primarily for removing tight diesel injectors from Volkswagen engines.



## 4M-045.4

Brand: Volkswagen - Audi  
 Product Code: 4M-045.4  
 OEM Tool Code: T40030

VW-Audi 3.0-V6, 5 valves per cylinder, since 2001.



## 4M-045.1

Brand: Volkswagen - Audi  
 Product Code: 4M-045.1  
 OEM Tool Code: T40005

T40005 Camshaft Alignment Tool for Audi 40VV-8



## 4M-045.2

Brand: Volkswagen - Audi  
 Product Code: 4M-045.2  
 OEM Tool Code: 3391

securing both engine banks/ camshafts at T.D.C when replacing the timing belt/ to properly align camshaft during timing belt change /head assembly work. Applicable VW Audi V6 5 Valve 1998-2003 Cam/Bar-Holder Not Applicable 3.0 2002 4 cam.

VW Volkswagen Audi Timing Tool VAG 3391  
 Camshaft Timing Tool REF 3391  
 Cam/Bar- Holder V6 / 5 valves per cylinder/ used for the crucial task of



## 4M-190

Brand: Volkswagen - Audi  
 Product Code: 4M-190  
 OEM Tool Code: T10252

Camshaft Locking Tool for the 2006-2008 VW/Audi 2.0L Turbo Engines (BPY).

T10252 VW-Audi Camshaft Locking Tool

Used in conjunction with: #T 40080, #T 10115 & #H 2587-2 And many more

Make	Model	Submodel	Engine
Audi	A3 8P	FWD	2.0T
Audi	A3 8P	Quattro	2.0T
Audi	B7 A4	FWD	2.0T
Audi	B7 A4	Quattro	2.0T
Volkswagen	Golf R	All	2.0T
Volkswagen	Golf V	All	2.0T
Volkswagen	Jetta V	All	2.0T
Volkswagen	Passat B6	FWD	2.0T



## 4M-303

*Brand:* Volkswagen - Audi  
*Product Code:* 4M-303  
*OEM Tool Code:* T10006/A  
T10006A Brake Servo Release Tool  
CTA Tools 1437 Brake Release Tool -  
VW/Audi is expertly designed and  
crafted to the exacting standards ex-  
pected from CTA Tools. Engineered for  
utilization when separating the brake  
servo push rod from the brake pedal.  
Featuring a special bend that allows  
separation of the brake servo push rod

from the brake pedal. This Brake  
Release Tool - VW/Audi is crafted with a  
rugged steel construction and is  
intended for use on all VW and Audi  
models. Whether tuning up your '68  
Corvette or changing the oil on a John  
Deere tractor, CTA can supply you with  
the tools needed to do the job. Califor-  
nia Prop 65 - Warning, This product  
contains chemicals known to the State  
of California to cause cancer, birth  
defects or other reproductive harm.



## 4M-110.2

*Brand:* Volkswagen - Audi  
*Product Code:* 4M-110.2  
*OEM Tool Code:* T10110

Locking camshaft T10110

For: Lupo 3L 1999 >



## 4M-114

*Brand:* Volkswagen - Audi  
*Product Code:* 4M-114  
*OEM Tool Code:* T10050

VAG 1,9Litre TDi PD DOHC and  
common engines fits Audi  
A3/A4/A5/A6 Skoda Octavia II  
Volkswagen Golf Jetta Touran

Specifically designed for Belt driven  
diesel engines.  
Also found on the Ford Galaxy  
models with ASZ and ASZ1 VAG  
engines.



## 4M-037.1

*Brand:* Volkswagen - Audi  
*Product Code:* 4M-037.1  
*OEM Tool Code:* VAG-2084

Crackshaft vibration damper VAG  
2084 5 cylinder Audi 3B NG KG



#### 4M-051

*Brand:* Volkswagen - Audi  
*Product Code:* 4M-051  
*OEM Tool Code:* VW381/14

Cone Socket with 1/2 drive, needed for R&R of grooved nut which retains pinion bearing within its housing.  
Applicable: Early VW air-cooled models



#### 4M-053

*Brand:* Volkswagen - Audi  
*Product Code:* 4M-053  
*OEM Tool Code:* VW381 15

Volkswagen VW381/15 Differential Socket for Air Cooled VW Type 2 Bus VW381/15



#### 4M-365

*Brand:* Volkswagen - Audi  
*Product Code:* 4M-365  
*OEM Tool Code:* T10466

VW Audi T10466 Clutch Bearings Gauge 7speed Dual Clutch OAM Transmission



#### 4M-114.2

*Brand:* Volkswagen - Audi  
*Product Code:* 4M-114.2  
*OEM Ref:* VAG 3359

Camshaft locking tool for VW - Audi (pump - nozzle). Bosch pump locking tool, for 4 cylinders vehicles VW - Audi, until 1982.



## 4M-198

Brand: Volkswagen - Audi  
Product Code: 4M-198  
OEM Tool Code: T10162

18mm triple square socket with a 1/2" drive, also often called a 12 point or xzn socket. The service manual refers to it as tool number T10162.

Applications where it is needed:  
- MKV and MKVI:  
- needed for removing the rear wheel bearing/hub.

Fits: VW - Touran 2004 and earlier,  
AUDI - A3 2004 and earlier

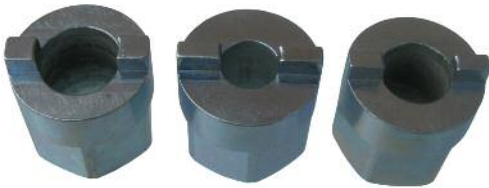

## 4M-041

Brand: Volkswagen - Audi  
Product Code: 4M-041

Universal strut nut tool set VW-Audi  
1. Internal Ø10.5mm with 3.5mm Pin  
2. Internal Ø12.5mm with 3.5mm Pin  
3. Internal Ø14.5mm with 5.0mm Pin



## 4M-067

Brand: Volkswagen - Audi  
Product Code: 4M-067  
OEM Tool Code: 3250

VW OEM 3250, Wishbone Support Frames VW T4



## 4M-067.1

Brand: Volkswagen - Audi  
Product Code: 4M-067.1

VW OEM 3250, Wishbone Support Frames VW T4 from 1995



## 4M-148

Brand: Volkswagen - Audi  
Product Code: 4M-148  
OEM Tool Code: VAG 3270

Camber adjustment tool.  
Used to adjust front wheel camber.  
CORRADO (VR6) PASSAT (VR6)  
GOLF/ JETTA 3.  
VAG 3270, Tensioner



## 4M-096.7

Brand: Volkswagen - Audi  
Product Code: 4M-096.7  
OEM Tool Code: T10402

Diesel injector remover for VAG vehicles fitted with 1.6 TDI, OEM T10402-Volkswagen Golf 2009, Seat Ibiza 2008, Altea 2009, Leon 2009, Altea XL 2009, Altea Freetrack 2009, Toledo 2013 and Audi A3 2009/2013.



## 4M-023

Brand: Volkswagen - Audi  
Product Code: 4M-023

Tool for the removal and replacement of steel clamps on the flange on exhaust manifolds, as installed in VW, Audi, Seat and Škoda vehicles.

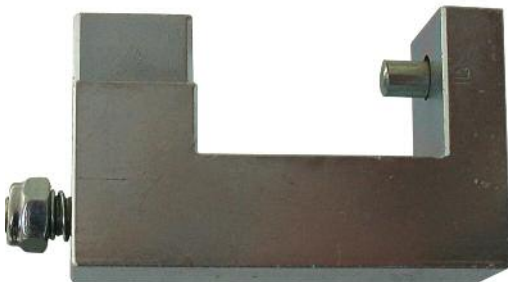

## 4M-092

Brand: Volkswagen - Audi  
Product Code: 4M-092

Visco Fan Locking Device  
Audi A4 1.8L and A4 1.9L TDI, VW Passat 1.8L 20V (ADP, ADR, AFY, AEB, AFN)



## 4M-112

Brand: Volkswagen - Audi  
Product Code: 4M-112

Tool For the axle shaft nut  
- BMW 3, 5 and 7 Series, Z3, M3,  
VW Polo since 2001, SEAT Ibiza  
since 2002  
- VW Golf Plus 1.8 TDi since 2005,  
Polo 5



## 4M-025.4

Brand: Volkswagen - Audi  
Product Code: 4M-025.4

Locking tool for camshaft  
VW- Audi, Seat, Škoda 4-cylinder  
1.9 TDi/SDI engines (except PD).  
Ideal for VW Golf (IV 1.9 TDi [110  
bhp) with aluminium valve cover.



## 4M-101

Brand: Volkswagen - Audi  
Product Code: 4M-101

Puller for Spacer Sleeves,  
VW-Audi group-Tool for vehicle  
models from 1988 onwards,  
such as VW Golf (II and III), Jetta,  
Vento, Polo, Passat, etc.



## 4M-026

Brand: Volkswagen - Audi  
Product Code: 4M-026

This front axle ball joint extractor  
installer can be used in situ.  
• Specifically designed for  
Volkswagen T4





## 4M-102

Brand: Volkswagen - Audi  
Product Code: 4M-102

This front axle ball joint extractor | installer can be used in situ. • Specifically designed for Volkswagen T2



## 4M-162

Brand: Volkswagen - Audi  
Product Code: 4M-162  
OEM Tool Code: T10051

Counter-holding when removing and installing camshaft sprocket. OEM -T10051. Audi A4 2016>, 4-cyl. TDI common rail 2.0 14V engine, Type / model: Audi A4 2016 >, Audi A5 2016>, Audi A6 2017>



## 4M-196

Brand: Volkswagen - Audi  
Product Code: 4M-196

CRANKSHAFT FACE MILL VW AUDI 1.9 TDI



## 4M-133

Brand: Volkswagen - Audi  
Product Code: 4M-133

Pin wrench for timing belt, used for adjusting timing belt tensioners for VW and Audi. With 2.9mm pins and 18mm spacing  
AUDI A3 1.9 TDi model year 1998 → 2003 · A4 1.6 model year 1995

→ 2006 · diesel SEAT Toledo 1.6 · 1.8 · 2.0 · 1.8 16V · 2.0 16V  
VW Golf 1.9 SDi · TDi model year 1997 → 2005 · Golf · Jetta · Passat 1.6 l diesel · Passat 1.6 model year 1996 → 2005 · Passat 2.0 model year 2001 → 2005 · Polo 1.9 SDi · TDi model year 1999 → 2006



## 4M-062

Brand: *Volkswagen - Audi*  
Product Code: 4M-062

Tool for Bosch injection pump -  
Bosch VE-Triangular socket for  
central closing plug



## 4M-064

Brand: *Volkswagen - Audi*  
Product Code: 4M-064

Tool for Bosch injection pump -  
Bosch VE-Governing pressure socket



## 4M-063

Brand: *Volkswagen - Audi*  
Product Code: 4M-063

Tool for Bosch injection pump -  
Bosch VE-Triangular socket for  
bearing screws governing lever



## 4M-089

Brand: *Volkswagen - Audi*  
Product Code: 4M-089

Tool for Bosch injection pump -  
Bosch VP EDC TDI-Triangular socket  
for body



## 4M-131.2

Brand: Volkswagen - Audi  
 Product Code: 4M-131.2  
 OEM Tool Code: T10163

Disassembly of the injector pump in 4-valve engines VW, AUDI, SEAT, SKODA 2.0 L TDI (89kW, 93kW, 103kW, 100kW) also MITSUBISHI 2.0 DI-D  
 • with Siemens pump injectors, also Bosch.



## 4M-913.SA

Brand: Volkswagen - Audi  
 Product Code: 4M-913.SA  
 Engine timing tool set for vag 2.5 / 4.9d / tdi pd; • suitable for VW T5 as of 2004, Touareg and Phaeton as of 2003 with 5 and 10 cylinder engines with engine code: AXD, AXE, BAC, BLJ, BLK, BNZ, BPC, BPD, BPE, • camshaft locking tool for review and adjustment, suitable for 5 and 10 cylinder engines, to be used as OEM T10193; • camshaft locking tool for

review and adjustment of 10 cylinder engines, to be used as OEM T10194; • clamping device for removal and replacement of the camshaft wheels of 5 and 10 cylinder engines, to be used as OEM T10199; • special socket for rotating the crankshaft of 5 cylinder engines, to be used as OEM T10225; • crankshaft locking wrench for 5 cylinder engines, to be used as OEM T10226



## 4M-061

Brand: Volkswagen - Audi  
 Product Code: 4M-061

Socket 27mm 1/2" - VW & BMW Injectors with E-Connector VW-Audi, BMW, Ford.

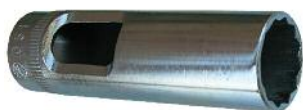

## 4M-061.1

Brand: Volkswagen - Audi  
 Product Code: 4M-061.1

Socket 22mm 1/2" - Mercedes-benz-Injector nozzle Socket  
 • E 300 Diesel (W124) w/ 3.0L OM606 Engine (1995)  
 • E 300D (W210) w/ 606.912 Engine (1996-1997)  
 E 300D (W210) w/ Turbo 606.962 Engine (1998-1999)



## 4M-041.1

Brand: Volkswagen - Audi  
Product Code: 4M-041.1

Strut nut socket - Internal  
Ø14.5mm with 5.0mm Pin



## 4M-033.1

Brand: Volkswagen - Audi  
Product Code: 4M-033.1

Ball Joint Puller for VW - Audi, Seat,  
Skoda, BMW, Mercedes



## 4M-037

Brand: Volkswagen - Audi  
Product Code: 4M-037  
OEM Tool Code: T10025

• Volkswagen Transporter 2.4D  
(95-03) and Volkswagen Crafter 2.5  
TDi (06-09)  
engine codes AAB, AJA, BJJ, BJK,  
BJL, BJM



## 4M-197

Brand: Volkswagen - Audi  
Product Code: 4M-197  
OEM Tool Code: 3424

Shock absorber bracket separation  
tool, VW - Audi



## 4M-302

Brand: Volkswagen - Audi  
Product Code: 4M-302  
OEM Tool Code: T50009

Crankshaft locking tool, LT, Crafter  
2006>5 cylinders, diesel VW - Audi

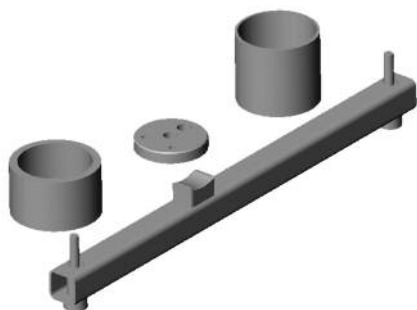

## 4M-306

Brand: Volkswagen - Audi  
Product Code: 4M-306  
OEM Tool Code: T10214 / T10244

Silent block carrier transmission  
positioning and replacement tool,  
VW - Audi



## 4M-143.1

Brand: Volkswagen - Audi  
Product Code: 4M-143.1  
OEM Tool Code: V.A.G-1926

Camber adjustment tool V.A.G 1926  
is required for wheel alignment on  
the Audi A8 front axle



## 4M-143

Brand: Volkswagen - Audi  
Product Code: 4M-143  
OEM Tool Code: V.A.G.1941

Camber adjustment tool VW Passat  
B5, Audi A4, Audi A6



## 4M-906.SA

Brand: *Volkswagen - Audi*  
 Product Code: 4M-906.SA  
 OEM Tool Code: T40061 / T40062 /  
 T40049 / T40058 / 3242 / T40060

Timing Tool Set to suit VAG 2.7 / 3.0 /  
 4.0 Tdi chain driven engines to lock  
 camshafts and crankshaft in position  
 when servicing the timing chain.

Models:  
 • Audi: A4 / A5 / A6 / A8 / Q7 /  
 Allroad  
 • VW: Phaeton / Touareg  
 Engines: ASE / BPP / BSG / ASB /  
 BKN / BMK / BMZ / BNG / BUG /  
 BUN / BKS / BTR / CAPA / CASA /  
 CARA



## 4M-025

Brand: *Volkswagen - Audi*  
 Product Code: 4M-025  
 OEM Tool Code: 2064

Diesel Engine Timing Tool Cam  
 Locking Pin Plate for VW Audi Volvo  
 2064, 2065A

- 1. Application: Diesel Engines: 1V, 1Z, AAB, ACV, AHU, AWP, AWW, CS, CY, DE, MD, ME & MF.
- D24 engine in all pre 1999 Volvo diesels. This includes the Penta Marine Diesel.
- 2. Diesel Cam Shaft Locking Plate OEM-2065A
- 3. LOCK PIN - INJECTION PUMP



## 4M-056

Brand: *Volkswagen - Audi*  
 Product Code: 4M-056

Auxiliary Belt Tensioner Wrench  
 VAG 1/2" D-  
 • Volkswagen Passat, Golf and Polo,  
 Polo Classic, Caddy 1993-99 1.9L Tdi  
 (AHL) and 1.9TDi (AHU) 2.0 Gti/GL  
 (ABA).  
 Use with 1/2" D ratchet or extension  
 bar.



## 4M-050

Brand: *Volkswagen - Audi*  
 Product Code: 050  
 OEM Tool Code: T10061

Oxygen Sensor Socket 22mm 7mm  
 Slot Lambda Lambda Tool 1/2" Drive



## 4M-186

Brand: Volkswagen - Audi  
 Product Code: 4M-186

VAG FRONT SUSPENSION BUSH RE-  
 MOVAL GARAGE TOOL  
 Suitable For The Removal /  
 Installation Of The Rear Mounting  
 Bush On The  
 Front Lower Wish-Bone.

Vw Polo ( 9N\_ )mk4 (01-09),  
 Polo (6A4) (02-on), Fox (5z1, 5Z3)  
 (03-on), Skoda Fabia (6Y2) (99-08),  
 Fabia Estate combi (6Y3, 6Y5) (99-  
 07), Rommster (5J) (07-on), Seat  
 Ibiza mk4 (typ 6L1) (02-09), Seat  
 Cordoba MK3 (6L2) (02-09), Audi  
 A3(99-on)



## 4M-022

Brand: Volkswagen - Audi  
 Product Code: 4M-022

REAR AXLE BUSH REMOVAL -  
 INSTALLER TOOL VW GOLF II,  
 GOLF III , PASSAT III



## 4M-178

Brand: Volkswagen - Audi  
 Product Code: 4M-178  
 OEM Tool Code: T3445

Camshaft Locking Tool is designed  
 to lock the camshaft of the 2.8lt  
 Diesel engines used in the popular  
 Volkswagen LT van.

- Applications include: Volkswagen  
 LT Van 1997 to 2006 2.8lt.
- Engine codes: AGK 1997<2006,  
 ATA 1999<2006, AUH 2001<2006,  
 BCQ 2002<2006.



## 4M-168

Brand: Volkswagen - Audi  
 Product Code: 4M-168

Tool designed to remove the inner  
 bearing race from the front wheel  
 hub. VW Golf (IV) with ABS-ring.



## 4M-301

Brand: Volkswagen - Audi  
Product Code: 4M-301  
OEM Tool Code: 3357

Specifically tool designed for gear box and sump plugs on Audi A3 | A4 | A6 models plus Volkswagen Golf IV & LT.

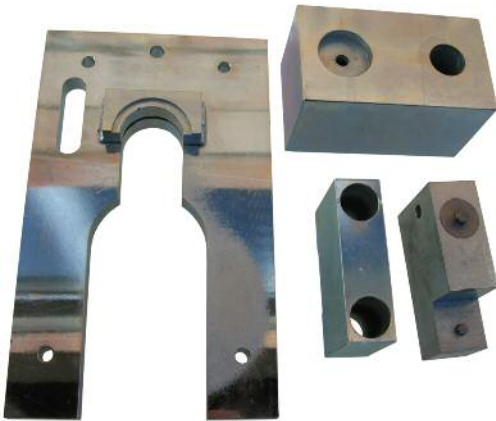

## 4M-337.SA

Brand: Volkswagen - Audi  
Product Code: 4M-337.SA  
OEM Tool Code: T10081 / T10083 / T10084A / T10080

Transmission repairs toolkit  
VW - Audi



## 4M-142.3

Brand: Volkswagen - Audi  
Product Code: 4M-142.3

Diesel injector seat cutter for  
VW-Audi 2.0 TDI



## 4M-142.4

Brand: Volkswagen - Audi  
Product Code: 4M-142.4

Diesel injector seat cutter for  
VW-Audi 1.9 TDI





#### 4M-096.14

Brand: Volkswagen - Audi  
Product Code: 4M-096.14

Diesel injector remover for VAG vehicles fitted with 2.0 TDI, OEM T10415 -Volkswagen Golf 2009, Seat Ibiza 2008, Altea 2009, Leon 2009, Altea XL 2009, Altea Freetrack 2009, Toledo 2013 and Audi A3 2009/2013.



#### 4M-165.1

Brand: Volkswagen - Audi  
Product Code: 4M-165.1  
OEM Tool Code: T10340

Crankshaft locking pin-Audi, VW 1.4L and 1.6L TSI FSI Engines - AXU, BAG, BKG, BLF, BLG, BLN, BLP, BMY, BTS, BWK, AXA (03+)



#### 4M-159

Brand: Volkswagen - Audi  
Product Code: 4M-159

Wheel Bearing Change Hub Automotive Tool Pullers -VW Lupo, Polo, AUDI A2, Seat, SKODA



#### 4M-159.SA

Brand: Volkswagen - Audi  
Product Code: 4M-159.SA

Wheel Bearing Change Hub Automotive Tool Pullers -VW Lupo, Polo, AUDI A2, Seat, SKODA, T5, Touareg, Volvo, VKBA 3569, VKBA 3660, VKBA 3646



## 4M-141.1

Brand: Volkswagen - Audi  
Product Code: 4M-141.1  
OEM Tool Code: V.A.G.-2078

Valve timing tool VW - Audi 4, 5, 6 cylinders from 1983.



## 4M-141

Brand: Volkswagen - Audi  
Product Code: 4M-141

Valve timing tool VW - Audi 4 cylinders until 1982.



## 4M-039

Brand: Volkswagen - Audi  
Product Code: 4M-039

Valve stem sealing rings removal tool (7mm, 8mm, 9mm), for VW, Audi.



## 4M-039.1

Brand: Volkswagen - Audi  
Product Code: 4M-039.1

Rubber valves removal tool (5 mm, 6 mm)



## 4M-362.SA

Brand: Volkswagen - Audi  
Product Code: 4M-362.SA  
OEM Tool Code: T40094 /  
T40095 / T40096

Diesel Camshaft/Head  
Rebuild Kit- VW-Audi



## 4M-165.2

Brand: Volkswagen - Audi  
Product Code: 4M-165.2  
OEM Tool Code: T10504 / T10504/1 /  
T10504/2

Camshaft Locking Tool Kit For VW  
Audi 1.4 TFSI Engine Timing Tool



## 4M-147.5

Brand: Volkswagen - Audi  
Product Code: 4M-147.5  
OEM Tool Code: T10477

Camshaft Locking Tool- VW, Audi -  
1.0L, 1.2L, 1.4L, 1.6L FSI  
engine. CHYB, CHYA



## 4M-367

Brand: Volkswagen - Audi  
Product Code: 4M-362.SA  
OEM Tool Code: T10202

Fuel Tank Wrench For VW Audi Q7  
A6L Fuel Pump  
Remover & Installer Special Engine  
Timing Tool Kits





## 4M-109

Brand: Opel  
Product Code: 4M-109

Astra F 1992 (1992-1997), Astra G 1998 (1998-2003), Corsa B 1993 (1993-2000)

Opel GM special tool setting motor  
X 17 D X 17 DT,  
• X17DTL- OEM- KM-851



## 4M-020

Brand: Opel  
Product Code: 4M-020

Tool for camshaft engine timing tool Opel Ascona Kadet 1.6 1.7 diesel



## 4M-135.1

Brand: Opel  
Product Code: 4M-135.1

Adjusting tool Opel Vauxhall X20 DTL/DTH, X22 DTX- KM-933



## 4M-135.2

Brand: Opel  
Product Code: 4M-135.2

Opel camshaft locking tool Vectra B, Omega B, setting timing X20DTL, X20DTH - OEM-KM-932  
Astra G 1998 (1998-2003), 1994 (1994-2003) Omega B, Vectra-B 1996 (1996-2002), Zafira-A 1999 (1999-2004)



### 4M-135.3

Brand: Opel  
Product Code: 4M-135.3  
OEM Tool Code: KM-929

OPEL Crankshaft locking Tool OPEL - Opel Vauxhall X20 DTL/DTH, X22 DTX KM932/Saab 83 95 386



### 4M-135.4

Brand: Opel  
Product Code: 4M-135.4  
OEM Tool Code: KM-927

Bosch injection pump timing pin Opel Opel Vauxhall X20 DTL/DTH, X22 DTX KM932/Saab 83 95 386 -



### 4M-135.SA

Brand: Opel  
Product Code: 4M-135.SA

Set tool for Opel Vauxhall X20 DTL/DTH, X22 DTX



### 4M-136.1

Brand: Opel  
Product Code: 4M-136.1  
OEM Tool Code: KM-954

OPEL-VAUXHALL-Camshaft Sensor Locating Tool



## 4M-136.2

Brand: Opel  
 Product Code: 4M-136.2  
 OEM Tool Code: KM-953

Camshaft locking tool, OPEL - DOHC  
 X 10 XE, X 12 XE



## 4M-136.3

Brand: Opel  
 Product Code: 4M-136.3  
 OEM Tool Code: KM-952

Camshaft TDC Position Guide Pin



## 4M-136.SA

Brand: Opel  
 Product Code: 4M-136.SA

Timing Chain Locking Tool for 1.2  
 1.4 Opel-Vauxhall



## 4M-136.4

Brand: Opel  
 Product Code: 4M-136.4  
 OEM Tool Code: KM-49978

Opel-Vauxhall-GM-Engine-Timing-  
 Tool

Designed to lock the crank shafts in  
 position to allow the removal and  
 replacement of the timing chain  
 fitted to the Vauxhall/Opel twin  
 Cam engines below. Removal of the  
 timing chain will re...



### 4M-119

Brand: Opel  
Product Code: 4M-119

Aids the removal and replacement of cam followers on 8 valve engine Suitable for Vauxhall/Opel.



### 4M-070.3

Brand: Opel  
Product Code: 4M-070.3  
OEM Tool Code: KM-46784

Fuel filter removal tools for Vauxhall/Opel Vectra, Fiat, Alfa Romeo 1.9 JTD and Saab 1.9D Equivalent to



### 4M-088

Brand: Opel  
Product Code: 4M-088

This rear link suspension bush tool is designed for Vauxhall Vectra 1.6/1.8/2.0 models (95>) and 2.5 models (96>).



### 4M-121

Brand: Opel  
Product Code: 4M-121  
OEM Tool Code: KM-825

Diesel injection pump puller BMW-13-5-120,



## 4M-332

Brand: Opel  
 Product Code: 4M-332  
 OEM Tool Code: KM-48245

CAMSHAFT TOOL OPEL VAUXHALL  
 DIESEL  
 Engine Codes: Z20DM | Z20DMH \\  
 LLWZ20DMH | RA420 | Z20SI |  
 Z20S3 | Z20S4 | Z20S5.  
 GM Antara | Chevrolet Captiva |  
 Cruze | Epica and Lacetti



## 4M-332.1

Brand: Opel  
 Product Code: 4M-332.1  
 OEM Tool Code: EN 48246

Crankshaft Locking Pin-OPEL VAUX-  
 HALL-EN-48246  
 Engine Codes: Z20DM | Z20DMH \\  
 LLWZ20DMH | RA420 | Z20SI |  
 Z20S3 | Z20S4 | Z20S5.  
 GM Antara | Chevrolet Captiva |  
 Cruze | Epica and Lacetti



## 4M-127.4

Brand: Opel  
 Product Code: 4M-127.4  
 OEM Tool Code: MOT-1534,  
 KM-6204

Crankshaft locking pin - Opel-  
 Renault- 2.2,2.5 diesel,



## 4M-181.1

Brand: Opel  
 Product Code: 4M-181.1  
 OEM Tool Code: MOT-1534  
 KM-6204

Inlet camshaft locking tool-  
 Renault-Opel 2.2,2.5 diesel,





## 4M-181.2

Brand: Opel  
Product Code: 4M-181.2  
OEM Tool Code: MOT-1537  
KM-6205

Exhaust camshaft locking tool-  
Renault-Opel 2.2,2.5 diesel,



## 4M-200.37

Brand: Opel  
Product Code: 4M-200.37  
OEM Tool Code: 1 870 896 900

Camshafts locking tool 1.9, 2.4-20v  
JTD 1.3 multi-jet Opel 1.9 CDTI



## 4M-200.38

Brand: Opel  
Product Code: 4M-200.38  
OEM Tool Code: 200 000 3000

Crankshaft locking tool Opel 1.9  
CDTI Fiat 1.9 JTD Alfa 1.9 JTD, 2.4  
JTD, 3.2 JTS



## 4M-902.SA

Brand: Opel  
Product Code: 4M-902.SA  
OEM Tool Code: KM-954 /KM-953  
/KM-952/KM-852-KM-853

OPEL-Timing Locking Setting Tool  
Kit - DOHC X10XE, X12XE,Z14XE,  
Z14XEP-1.4 1.6 -16V - 1.8 2.0 -16V



## 4M-904.SA

Brand: Opel  
 Product Code: 4M-904.SA  
 OEM Tool Code: 1 860 985 000 - EN  
 - 46781 - EN - 46785-1 870 900 300  
 /1 870 900 300 / 1 870 896 900  
 /200 000 3000

Timing setting tool kit OPEL cdti -  
 FIAT multi-jet



## 4M-070.8

Brand: Opel  
 Product Code: 4M-070.8

Oil filter Wrench Renault  
 Master, Movano, 97x14 ribs



## 4M-127.6

Brand: Opel  
 Product Code: 4M-127.6  
 OEM Tool Code: MOT-1766

Locking pin Renault 2.0 dci,  
 Opel



## 4M-342.1

Brand: Opel  
 Product Code: 4M-342.1  
 OEM Tool Code: KM-49977-100

Camshaft Sensor Disc Setting Tool  
 Opel, Chevrolet-A14XER, A14NEL,  
 A14NET



## 4M-342.2

Brand: Opel  
Product Code: 4M-342.2  
OEM Tool Code: KM-49977-200

Inlet Camshaft Adjuster Tool Opel,  
Chevrolet-A14XER, A14NEL,  
A14NET



## 4M-150

Brand: Opel  
Product Code: 4M-150

Diesel injector puller-Opel-2.0 DTL,  
DTH



## 4M-170

Brand: Opel  
Product Code: 4M-170  
OEM Tool Code: KM-6628

Camshaft locking tool, OPEL  
1.6XER, 1.8XER, Chevrolet, Fiat, Alfa  
Romeo



## 4M-170.1

Brand: Opel  
Product Code: 4M-170.1

Camshaft gear locking tool-OPEL-  
OEM-KM-6340, Fiat, Alfa Romeo-  
OEM-2 000 012 100, Chevrolet



## 4M-170.2

Brand: Opel  
Product Code: 4M-170.2  
OEM Tool Code: KM-6626

Flywheel locking tool Opel,  
1.6XER, 1.8XER



## 4M-323

Brand: Opel  
Product Code: 4M-323  
OEM Tool Code: MOT-1769

Camshaft locking tool 2.0 dCi-  
Renault, Nissan, Opel



## 4M-315

Brand: Opel  
Product Code: 4M-315  
OEM Tool Code: 0 470 004 003

Fuel solenoid wrench -Opel 1.7 DTL,  
1.7 DTH



**4M-097.4**

Brand: BMW  
 Product Code: 4M-097.4  
 OEM Tool Code: 11 2 300

Crankshaft locking tool BMW



**4M-193**

Brand: BMW  
 Product Code: 4M-193

Rear silent blocks replacement tool  
 BMW E-39 – caravan



**4M-121**

Brand: BMW  
 Product Code: 4M-121  
 OEM Tool Code: KM-825

Bosch pump chain sprocket  
 support tool BMW-M21, OPEL 2,5  
 TDS



**4M-121.1**

Brand: BMW  
 Product Code: 4M-121.1  
 OEM Tool Code: 13 5 190

Common rail high pressure pump  
 removal tool



**4M-121.3**

Brand: BMW  
 Product Code: 4M-121.3  
 OEM Tool Code: 11 9 340

Timing Chain Pre-Tensioning Tool



**4M-145**

Brand: BMW  
 Product Code: 4M-145  
 OEM Tool Code: 11 6 321/2

Camshafts locking tool BMW diesel  
 M47, M57 Opel Omega



**4M-077**

Brand: BMW  
 Product Code: 4M-077

Rear silent blocks on site  
 replacement tool for BMW  
 vehicles series 3, 5, 7 and E36



**4M-093**

Brand: BMW  
 Product Code: 4M-093

Front balls replacement tool BMW  
 E30 (to use with article no. 100)



## 4M-076

Brand: BMW  
Product Code: 4M-076

Front ball-joint replacement tool  
BMW E36 (to use with article no.  
100)



## 4M-097

Brand: BMW  
Product Code: 4M-097  
OEM Tool Code: 11 3 190

Camshaft locking tools BMW: M40,  
M43, M70, M73



## 4M-097.2

Brand: BMW  
Product Code: 4M-097.2  
OEM Tool Code: 11 3 240

Camshaft locking tools BMW M42



## 4M-097.3

Brand: BMW  
Product Code: 4M-097.3  
OEM Tool Code: KM-811

Camshaft locking tool BMW 325td /  
tds (E6) BMW 52td / tds (E43/E49)  
Opel Omega 2,5 TD, BMW 318 tds  
(E36)



**4M-070.1**

Brand: BMW  
Product Code: 4M-070.1

Filter cartridge removal tool BMW  
316i, 316 ti, 318 Ci, Volvo V40, S40,  
S70



**4M-094**

Brand: BMW  
Product Code: 4M-094

Back bearing on site replacement  
tool BMW E34 (series 5)



**4M-096.1**

Brand: BMW  
Product Code: 4M-096.1

Injectors extraction tool BMW CR  
Mercedes CDI



**4M-182**

Brand: BMW  
Product Code: 4M-182

Suspension balls replacement tool  
BMW E-38, E-39





## 4M-191

Brand: BMW  
Product Code: 4M-191

Rear silent blocks replacement tool  
BMW E46



## 4M-914.SA

Brand: BMW  
Product Code: 4M-914.SA  
OEM Tool Code: 119290-292CE11-06 / 119350-351CE11-06 / 119290-291CE11-06 / 119190 CZ01-06 / 119340-341 N12-05

Timing setting tool kit GMT- BMW  
118i/120i(E87), 318i/320i(E90),  
Z4-2.0(E85), 316i, 316ti(E46), 318i,  
318ti(E46), N42, N46



## 4M-915.SA

Brand: BMW  
Product Code: 4M-915.SA  
OEM Tool Code: 11 4 280 / 11 4 290 / 11 0 300 / 11 9 340 / 11 8 520

Timing setting tool kit GMT BMW  
N51, N52, N52K, N53, N54



## 4M-338

Brand: BMW  
Product Code: 4M-338

Drive axle adjustment tool BMW-  
M24x1.5



**4M-338.1**

Brand: BMW  
Product Code: 4M-338.1

Drive axle adjustment tool BMW-M27x1.5



**4M-401**

Brand: BMW  
Product Code: 4M-401

Rear silent blocks replacement tool BMW E39 E60 (to use as specified in article 4M-400)



**4M-005.2**

Brand: BMW  
Product Code: 4M-005.2

Groove joint removal tool BMW



**4M-340.SA**

Brand: BMW  
Product Code: 4M-340.SA  
OEM Tool Code: 11 8 760; 11 5 320;  
11 3 340; 11 6 480; 11 9 340

Timing setting tool kit GMT BMW N47, N47S



## 4M-335.SA

Brand: BMW  
Product Code: 4M-335.SA  
OEM Tool Code: 11 9 461; 11 9 462;  
11 9 463; 11 9 190

Timing setting tool kit GMT BMW  
N62-V8, N73-V12



## 4M-343

Brand: BMW  
Product Code: 4M-343

Crankshaft pulley support tool  
(during extraction)  
BMW - E39-2.0 d

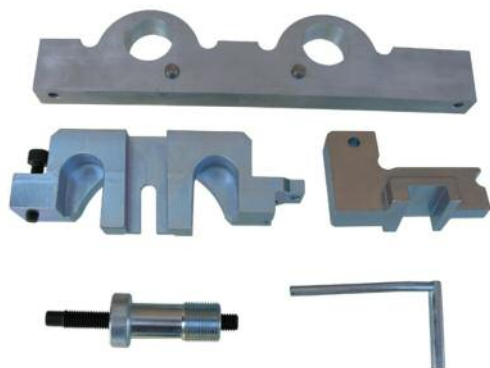

## 4M-916.SA

Brand: BMW  
Product Code: 4M-916.SA  
OEM Tool Code: 11 7 251 / 11 7 260  
/ 11 7 252 / 11 9 190 / 11 9 340

Timing setting tool kit GMT BMW-  
N40, N45, N45T



## 4M-340.5a

Brand: BMW  
Product Code: 4M-340.5a

Secure special tool 11 8 750 to the  
crankcase using the two screws (1)  
for the coolant pump B47



**4M-324**

Brand: BMW  
Product Code: 4M-324

Differential Silent block replacement tool for BMW X5, X6



**4M-352.SA**

Brand: BMW  
Product Code: 4M-352.SA  
OEM Tool Code: 11 8 690 / 11 8 700 / 11 8 710 / 11 5 120

Timing setting tool kit GMT BMW N43



**4M-340.5**

Brand: BMW  
Product Code: 4M-340.5  
OEM Tool Code: 11 8 750

Secure special tool 11 8 750 to the crankcase using the two screws (1) for the coolant pump



**4M-368.SA**

Brand: BMW  
Product Code: 4M-368.SA  
OEM Tool Code: 83 302 212 831; 83 302 212 830; 83 30 2 219 548

Timing setting tool kit BMW N20



## 4M-361.SA

*Brand:* BMW

*Product Code:* 4M-361.SA

*OEM Tool Code:* 11 3 290; 11 4 220;  
11 3 450; 11 6 180; 11 6 150

Timing setting tool kit BMW 528i

X5, E46, Z3.Z4, 325, 525, M52,  
M54, M56



## 4M-116

Brand: Renault  
Product Code: 4M-116

Pulley and Bosch pump locking tool Renault, Mitsubishi, Opel, Volvo Diesel 1.9 (F8Q i F9Q)



## 4M-127.7

Brand: Renault  
Product Code: 4M-127.7  
OEM Tool Code: MOT-1526

Camshafts locking tool Renault Laguna II ('01-'05) 2.0 IDE Megan ('99-'03) 2.0 IDE for F5R engine code



## 4M-070.2

Brand: Renault  
Product Code: 4M-070.2  
OEM Tool Code: MOT-1330

Oil filters replacement tool Renault, Fiat, Toyota, etc. Ø 66-6 teeth



## 4M-070.4

Brand: Renault  
Product Code: 4M-070.4  
OEM Tool Code: MOT-1329

Oil filters replacement tool Ø 76 12 teeth Peugeot, Renault...



## 4M-127

Brand: Renault  
Product Code: 4M-127  
OEM Tool Code: MOT-1496

Camshaft Locking Tool Renault  
For engine:  
1.4 16V  
1,6 16V  
1,6 16V  
1,8 16V  
2,0 16V



## 4M-127.1

Brand: Renault  
Product Code: 4M-127.1  
OEM Tool Code: MOT-1489

Crankshaft locking tool for Renault  
1.4; 1.6 - 16V; 1.5 DCI.



## 4M-127.2

Brand: Renault  
Product Code: 4M-127.2  
OEM Tool Code: MOT 1054  
861

RENAULT OEM MOT 1054 OEM 861  
ENGINE TIMING PIN LOCKING TOOL



## 4M-127.3

Brand: Renault  
Product Code: 4M-127.3  
OEM Tool Code: MOT-1430-01

Camshaft locking tool Renault  
1.5DCI.



## 4M-158

Brand: Renault  
Product Code: 4M-158

Ball-joint (both) on site replacement tool Renault Master, Opel Movano (to use with article no. 4M-100)



## 4M-167

Brand: Renault  
Product Code: 4M-167  
OEM Tool Code: MOT 1490-01

Camshafts gears locking tool  
Renault - Opel



## 4M-169

Brand: Renault  
Product Code: 4M-169

Rear silent blocks replacement tool  
Renault - Laguna



## 4M-181

Brand: Renault  
Product Code: 4M-181  
OEM Tool Code: MOT-1534, 1537

Timing Lock Tool Kit RENAULT,  
OPEL- 2.2 DCI, 2.5 DTI





#### 4M-181.1

Brand: Renault  
Product Code: 4M-181.1

Camshaft locking tool Renault -  
Opel 2.2, 2.5 diesel  
MOT-1534, KM-6204



#### 4M-181.2

Brand: Renault  
Product Code: 4M-181.2  
OEM Tool Code: MOT-1537  
KM-6205

Camshaft locking tool Renault -  
Opel - 2.2, 2.5 diesel



#### 4M-072.1

Brand: Renault  
Product Code: 4M-072.1

Alternator pulley loosening tool  
Renault - OK 28



#### 4M-070.8

Brand: Renault  
Product Code: 4M-070.8

Oil filter replacement tool Master,  
Movano 97x14

## 4M-142.2

Brand: Renault  
Product Code: 4M-142.2

Diesel injector seat cutter for PSA,  
Renault, Mercedes



## 4M-195.1

Brand: Renault  
Product Code: 4M-195.1

Cylinder block nozzle removal tool  
Renault 1,5 DCI-1.9DCI



## 4M-309

Brand: Renault  
Product Code: 4M-309

Front wheel ball mounting and  
removal tool - Renault Megan II



## 4M-909.SA

Brand: Renault  
Product Code: 4M-909.SA  
OEM Tool Code: MOT-1496 /  
MOT-1489 / MOT-1054 /  
MOT-1430-01 / MOT-1536 /  
MOT-1766 / MOT-1534, 1537

Renault Timing Locking Setting Tool  
Kit





## 4M-344

Brand: Renault  
Product Code: 4M-344

Shaft separation tool Renault, Dacia



## 4M-323

Brand: Renault  
Product Code: 4M-323  
OEM Tool Code: MOT 1769

Camshaft locking tool Renault,  
Nisan, Opel - 2.0 dci



## 4M-096.16

Brand: Renault  
Product Code: 4M-096.16  
OEM Tool Code: MOT 1966

Injectors pulling tool-Renault 2.0  
dci



## 4M-096.17

Brand: Renault  
Product Code: 4M-096.17

Injector pulling tool-2.0 dci -  
Hydraulic cylinder-171.2



## 4M-323.1

*Brand:* Renault  
*Product Code:* 4M-323.1  
*OEM Tool Code:* MOT 1969

Camshaft locking tool Renault,  
Nisan, Opel -1.6DCI



## 4M-323.2

*Brand:* Renault  
*Product Code:* 4M-323.2  
*OEM Tool Code:* MOT 1970

Camshaft locking tool Renault,  
Nisan, Opel -1.6DCI



## 4M-014

Brand: Peugeot/Citroën  
Product Code: 4M-014

Front ball replacement tool Citroën  
BX, XM, Peugeot 405, 307



## 4M-014.1

Brand: Peugeot/Citroën  
Product Code: 4M-014.1

Front ball replacement tool C4,  
Peugeot 307



## 4M-014.2

Brand: Peugeot/Citroën  
Product Code: 4M-014.2

Front ball replacement tool  
Peugeot 407 Citroën C5



## 4M-015

Brand: Peugeot/Citroën  
Product Code: 4M-015

Front ball on site mounting and  
removal tool Citroën AX and  
Peugeot 106.

## 4M-142.2

Brand: Peugeot/Citroën  
Product Code: 4M-142.2

Diesel injector seat cutter for PSA,  
Renault, Mercedes



## 4M-142.6

Brand: Peugeot/Citroën  
Product Code: 4M-142.6

Diesel injector seat cutter for PSA  
2.0 HDI



## 4M-070.4

Brand: Peugeot/Citroën  
Product Code: 4M-070.4  
OEM Tool Code: MOT-1329

Oil filters replacement tool  $\varnothing$  76 12  
teeth Peugeot, Renault...



## 4M-179

Brand: Peugeot/Citroën  
Product Code: 4M-179

Front silent block replacement tool  
Citroën Jumper Peugeot Boxer





## 4M-304

Brand: Peugeot/Citroën  
Product Code: 4M-304  
OEM Tool Code: 1860161000

Flywheel locking tool Fiat, Peugeot, Citroen, etc.



## 4M-341.SA

Brand: Peugeot/Citroën  
Product Code: 4M-341.SA  
OEM Tool Code: 0194A,21-260 /  
0194B,21-263 / 0194C,21-262 /  
119850

Positioning tool GMT Peugeot, Citroen, Mini, Mazda, Ford, Toyota, Volvo 1.4, 1.6 HDI



## 4M-346.SA

Brand: Peugeot/Citroën  
Product Code: 4M-346.SA  
OEM Tool Code: 0197-A1

MINI/PEUGEOT/CITROEN / -  
N12,N14 R55, R56 1.4 1.6 CAM  
TIMING SETTING TOOL KIT



## 4M-080

Brand: Ford  
Product Code: 4M-080

Full speed gears removal tool -  
Ford



## 4M-095

Brand: Ford  
Product Code: 4M-095  
OEM Tool Code: 21-162B; 303-376

Camshaft locking tools for Ford  
vehicles with ZETEC engines



## 4M-129

Brand: Ford  
Product Code: 4M-129  
OEM Tool Code: 21-104; 303-193

Crankshaft locking tool Ford 1.8



## 4M-129.1

Brand: Ford  
Product Code: 4M-129.1  
OEM Tool Code: 21-210; 303-507

Crankshaft locking tool Ford 1.25,  
1.4, 1.6, 1.8, 2.0 16V





## 4M-129.2

*Brand:* Ford  
*Product Code:* 4M-129.2  
*OEM Tool Code:* 21-163; 303-574

Crankshaft locking tool Ford 1.6,  
1.8, 2.0 16V 1.7 ZETEC



## 4M-129.6

*Brand:* Ford  
*Product Code:* 4M-129.6  
*OEM Tool Code:* 21-259; 303-748

Crankshaft locking tool - Ford



## 4M-129.7

*Brand:* Ford  
*Product Code:* 4M-129.7  
*OEM Tool Code:* 21-251

Camshaft locking tool Ford -  
Mondeo, Transit - FMBA/B, D5BA,  
ABFA, D3FA, F3FA, D2FA,  
D4FA, F4FA



## 4M-129.8

*Brand:* Ford  
*Product Code:* 4M-129.8  
*OEM Tool Code:* 21-234/303-675

Camshaft locking tool FMBA/B,  
D5BA, ABFA, D3FA, F3FA, D2FA,  
D4FA, F4FA



## 4M-129.9

Brand: Ford  
Product Code: 4M-129.9  
OEM Tool Code: 303-1097

Camshaft locking tool for Ford  
/Volvo - 1.6 SCTi/Ti-VCT Eco-boost



## 4M-176

Brand: Ford  
Product Code: 4M-176

Timing valve tool Ford



## 4M-079

Brand: Ford  
Product Code: 4M-079

Gear locking tool FORD



## 4M-200.1

Brand: Fiat, Alfa, Lancia  
Product Code: 4M-200.1  
OEM Tool Code: 1 825 041 000

Camshafts locking tool Alfa 145,  
146, 147, 155, 156, 166, GTV,  
SPIDER - 1.8/2.0TS 16V



## 4M-200.2

Brand: Fiat, Alfa, Lancia  
Product Code: 4M-200.2  
OEM Tool Code: 1 860 905 000 /  
2 000 003 000

Crankshaft locking tool - Fiat 1.9  
D/TD/JTD; 2.4TD/JTD Peugeot/-  
Citroën 1.9 D/TD; 2.1 TD



## 4M-200.3

Brand: Fiat, Alfa, Lancia  
Product Code: 4M-200.3  
OEM Tool Code: 1 825 042 000

Camshafts locking tool Alfa 145,  
146, 156 - 1.4/1.6TS 16V

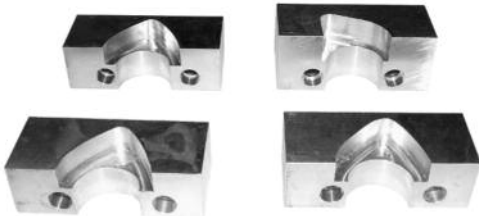

## 4M-200.4

Brand: Fiat, Alfa, Lancia  
Product Code: 4M-200.4  
OEM Tool Code: 1 825 040 000

Camshafts locking tool Fiat, Alfa,  
Lancia - 2.5/3.0 V6 (12V, 24V)



## 4M-200.5

*Brand:* Fiat, Alfa, Lancia  
*Product Code:* 4M-200.5

Chain tensioner locking tool Alfa Romeo 156.2.5 V6 24V Alfa Romeo 166.2.0 V6 Turbo Alfa Romeo 166.2.5 V6 24V Alfa Romeo 166.3.0 V6 24V



## 4M-200.6A

*Brand:* Fiat, Alfa, Lancia  
*Product Code:* 4M-200.6A  
*OEM Tool Code:* 1 860 931 000

Camshafts locking tool A: Fiat, Alfa, Lancia - 1.9 TD B: Fiat - 1.7 D/TD C: Fiat - 1.9 D



## 4M-200.6B

*Brand:* Fiat, Alfa, Lancia  
*Product Code:* 4M-200.6B  
*OEM Tool Code:* 1 860 932 000

Camshafts locking tool A: Fiat, Alfa, Lancia - 1.9 TD B: Fiat - 1.7 D/TD C: Fiat - 1.9 D



## 4M-200.6C

*Brand:* Fiat, Alfa, Lancia  
*Product Code:* 4M-200.6C  
*OEM Tool Code:* 1 860 934 000

Camshafts locking tool A: Fiat, Alfa, Lancia - 1.9 TD B: Fiat - 1.7 D/TD C: Fiat - 1.9 D



## 4M-200.7

Brand: Fiat, Alfa, Lancia  
Product Code: 4M-200.7  
OEM Tool Code: 1 860 898 000

Flywheel locking tool Fiat Punto 1.9  
JTD Fiat Punto 1.9 D



## 4M-200.8

Brand: Fiat, Alfa, Lancia  
Product Code: 4M-200.8  
OEM Tool Code: 1 860 933 000

Crankshaft locking tool Fiat Punto  
1.7 D Fiat Punto 1.7 TD Fiat Punto  
1.9 D



## 4M-200.9

Brand: Fiat, Alfa, Lancia  
Product Code: 4M-200.9  
OEM Tool Code: 1 860 899 000

Camshafts locking tool Fiat, Lancia -  
1.4 12 V



## 4M-200.10

Brand: Fiat, Alfa, Lancia  
Product Code: 4M-200.10  
OEM Tool Code: 1 860 901 000

Crankshaft locking tool Fiat Bravo  
1.4; Fiat Marea 1.4; Lancia Delta



## 4M-200.11

Brand: Fiat, Alfa, Lancia  
Product Code: 4M-200.11  
OEM Tool Code: 1 860 874 000

Camshafts locking tool Fiat Bravo 1.6; Fiat Marea 1.6 16V; Fiat Multipla; Lancia Delta 1.6 16V; Lancia Lybra 1.6 16V



## 4M-200.12

Brand: Fiat, Alfa, Lancia  
Product Code: 4M-200.12  
OEM Tool Code: 1 860 876 001

Chain tensioner locking tool Fiat Bravo 1.6; Fiat Marea 1.6 16V; Fiat Multipla; Lancia Delta 1.6 16V; Lancia Lybra 1.6 16V



## 4M-200.13

Brand: Fiat, Alfa, Lancia  
Product Code: 4M-200.13  
OEM Tool Code: 1 860 771 000

Flywheel locking tool - Fiat Bravo 1.6; Fiat Marea 1.6 16V; Fiat Multipla; Lancia Delta 1.6 16V; Lancia Lybra 1.6 16V



## 4M-200.14

Brand: Fiat, Alfa, Lancia  
Product Code: 4M-200.14  
OEM Tool Code: 1 860 875 000

Camshafts locking tool Fiat, Lancia - 1.8 16V



## 4M-200.15

Brand: Fiat, Alfa, Lancia  
Product Code: 4M-200.15  
OEM Tool Code: 1 860 892 000

Camshafts locking tool Fiat - 2.0 5 C



## 4M-200.16

Brand: Fiat, Alfa, Lancia  
Product Code: 4M-200.16  
OEM Tool Code: 1 860 847 000

Camshafts locking tool Fiat, Lancia - 1.8 16V



## 4M-200.17

Brand: Fiat, Alfa, Lancia  
Product Code: 4M-200.17  
OEM Tool Code: 1 860 819 000

Camshafts locking tool  
Lancia 2.4 5 C



## 4M-200.18

Brand: Fiat, Alfa, Lancia  
Product Code: 4M-200.18  
OEM Tool Code: 1 870 896 500

Dial gauge (reduction) tool Fiat Alfa  
Lancia



## 4M-200.19A

Brand: Fiat, Alfa, Lancia  
Product Code: 4M-200.19A  
OEM Tool Code: 1 822 149 000

Chain tensioner tightening tool  
Fiat, Alfa, Lancia



## 4M-200.19B

Brand: Fiat, Alfa, Lancia  
Product Code: 4M-200.19B  
OEM Tool Code: 1 822 154 000

Chain tensioner tightening tool  
Fiat, Alfa, Lancia



## 4M-200.21A

Brand: Fiat, Alfa, Lancia  
Product Code: 4M-200.21A  
OEM Tool Code: 1 860 992 000

Ignition phase tool Fiat 1.2 - 1.6V



## 4M-200.21B

Brand: Fiat, Alfa, Lancia  
Product Code: 4M-200.21B  
OEM Tool Code: 1 860 985 000

Ignition phase tool Fiat 1.2 - 1.6V





## 4M-200.22

Brand: Fiat, Alfa, Lancia  
Product Code: 4M-200.22

Timing valve tool, Zastava - Fiat



## 4M-200.23

Brand: Fiat, Alfa, Lancia  
Product Code: 4M-200.23  
OEM Tool Code: 1 860 818 000

Camshafts locking tool Fiat, Lancia  
2.0 5 C



## 4M-200.24

Brand: Fiat, Alfa, Lancia  
Product Code: 4M-200.24  
OEM Tool Code: 1 860 961 000

Camshafts locking tool Fiat, Lancia  
2.0 5 C 20V Turbo

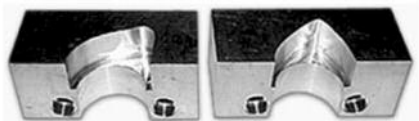

## 4M-200.25

Brand: Fiat, Alfa, Lancia  
Product Code: 4M-200.25  
OEM Tool Code: 1 870 697 000

Camshafts locking tool Fiat, Lancia  
1.8 16 V

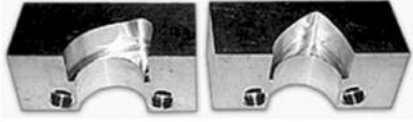

## 4M-200.26

*Brand:* Fiat, Alfa, Lancia  
*Product Code:* 4M-200.26  
*OEM Tool Code:* 1 870 797 000

Camshafts locking tool Alfa 147 1.6  
TS 2.0 TS 103 KS

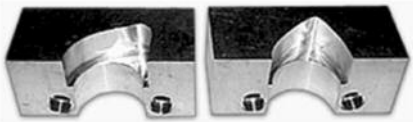

## 4M-200.27

*Brand:* Fiat, Alfa, Lancia  
*Product Code:* 4M-200.27  
*OEM Tool Code:* 1 870 859 000

Camshafts locking tool Alfa 147,  
156, 166, GT, GTV/SPIDER 2.0 JTS



## 4M-200.28

*Brand:* Fiat, Alfa, Lancia  
*Product Code:* 4M-200.28  
*OEM Tool Code:* 1 870 828 000

Camshafts locking tool Fiat Stilo 2.4  
5C, Lancia Thesis 2.0 Turbo, 2.4 BZ

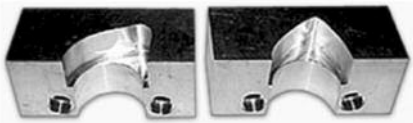

## 4M-200.29

*Brand:* Fiat, Alfa, Lancia  
*Product Code:* 4M-200.29  
*OEM Tool Code:* 1 870 734 000

Camshafts locking tool Alfa 145,  
146, 147 1.6 TS 16V 120 KS



## 4M-200.30

Brand: Fiat, Alfa, Lancia  
Product Code: 4M-200.30  
OEM Tool Code: 1 860 962 000

Camshafts locking tool Fiat Coupe  
2.0 16 V Turbo, Lancia Kappa 2.0 5C  
Turbo, Lancia  
Thesis 2.0 Turbo



## 4M-200.31

Brand: Fiat, Alfa, Lancia  
Product Code: 4M-200.31  
OEM Tool Code: 1 860 822 000

Oil pump positioning tool Fiat - HGT



## 4M-200.32

Brand: Fiat, Alfa, Lancia  
Product Code: 4M-200.32  
OEM Tool Code: 2 000 004 400 /  
2 190 754 400

Camshaft locking tool Fiat 1.4  
Punto Grande



## 4M-200.33

Brand: Fiat, Alfa, Lancia  
Product Code: 4M-200.33  
OEM Tool Code: 1 822 147 000

Variator tool Alfa



## 4M-200.34

Brand: Fiat, Alfa, Lancia  
Product Code: 4M-200.34

Pre-chamber removal tool Fiat



## 4M-200.35

Brand: Fiat, Alfa, Lancia  
Product Code: 4M-200.35  
OEM Tool Code: 1 860 987 000

Chain tensioner tightening tool Fiat



## 4M-200.36

Brand: Fiat, Alfa, Lancia  
Product Code: 4M-200.36  
OEM Tool Code: 1 870 900 300

Crankshaft locking tool Fiat 1.3 multi-jet



## 4M-200.37

Brand: Fiat, Alfa, Lancia  
Product Code: 4M-200.37  
OEM Tool Code: 1 870 896 900

Camshafts locking tool 1.9, 2.4-20v JTD 1.3 multi-jet Opel 1.9 CDTI



### 4M-200.38

Brand: Fiat, Alfa, Lancia  
Product Code: 4M-200.38  
OEM Tool Code: 200 000 3000

Crankshaft locking tool Opel 1.9  
CDTI Fiat 1.9 JTD Alfa 1.9 JTD, 2.4  
JTD, 3.2 JTS



### 4M-200.39

Brand: Fiat, Alfa, Lancia  
Product Code: 4M-200.39  
OEM Tool Code: 1 860 766 000

Flywheel locking tool Diesel



### 4M-200.40

Brand: Fiat, Alfa, Lancia  
Product Code: 4M-200.40  
OEM Tool Code: 2 000 004 500 /  
2 190 754 500

Crankshaft locking tool Grande  
Punto 1.4-16V



### 4M-200.43

Brand: Fiat, Alfa, Lancia  
Product Code: 4M-200.43

Rear silent blocks replacement tool,  
Fiat Stilo (to use with article no.  
100)



## 4M-200.44

Brand: Fiat, Alfa, Lancia  
Product Code: 4M-200.44  
OEM Tool Code: 1 870 753 001

Gearbox locking tool Alfa 147/156  
1.6, 2.0



## 4M-200.45

Brand: Fiat, Alfa, Lancia  
Product Code: 4M-200.45  
OEM Tool Code: 99360615-C.F.4458

Crankshaft locking tool Fiat Ducato  
2.3 JTD Iveco 3.0



## 4M-200.46

Brand: Fiat, Alfa, Lancia  
Product Code: 4M-200.46  
OEM Tool Code: 99360614-C.F.4458

Camshaft locking tool Fiat Ducato  
2.3 JTD Iveco 3.0



## 4M-200.47

Brand: Fiat, Alfa, Lancia  
Product Code: 4M-200.47

Crankshaft locking tool, Zastava 10,  
Fiat 1.2-8v



### 4M-200.48

Brand: Fiat, Alfa, Lancia  
Product Code: 4M-200.48

Camshaft locking tool, Zastava 10,  
Fiat 1.2-8v



### 4M-200.49

Brand: Fiat, Alfa, Lancia  
Product Code: 4M-200.49  
OEM Tool Code: 1 870 849 000

Camshaft locking tool-Alfa 3.2



### 4M-200.50

Brand: Fiat, Alfa, Lancia  
Product Code: 4M-200.50  
OEM Tool Code: 2 000 034 400

Camshaft positioning tool 1.4  
multi-air Fiat Punto Evo, Bravo Alfa  
Romeo, Mito, Giulietta Lancia Delta



### 4M-200.54

Brand: Fiat, Alfa, Lancia  
Product Code: 4M-200.54

Rear silent blocks replacement tool  
Fiat Punto (to use as specified in  
item 4M-100)



## 4M-200.56

Brand: Fiat, Alfa, Lancia  
Product Code: 4M-200.56

Fuel tank nut removal tool for Fiat Punto



## 4M-200.57

Brand: Fiat, Alfa, Lancia  
Product Code: 4M-200.57  
OEM Tool Code: 2 000 035 100

Camshaft locking tool, Fiat 500 i  
500c Twin air 900 kub.



## 4M-200.58

Brand: Fiat, Alfa, Lancia  
Product Code: 4M-200.58  
OEM Tool Code: 2 000 035 200

Crankshaft locking tool Fiat 500 i  
500c Twin air 900 kub.



## 4M-070.2

Brand: Fiat, Alfa, Lancia  
Product Code: 4M-070.2  
OEM Tool Code: MOT-1330

Oil filters replacement tool Renault,  
Fiat, Toyota, etc. Ø 66-6 teeth





### 4M-070.3

Brand: Fiat, Alfa, Lancia  
Product Code: 4M-070.3  
OEM Tool Code: EN-46784

Fuel filter replacement tool Opel  
1.3 CDTI Fiat 1.3 D – multi-jet



### 4M-161.SA

Brand: Fiat, Alfa, Lancia  
Product Code: 4M-161.SA  
OEM Tool Code: 1 860 985 000 /  
EN-46781 / EN-46785  
1 870 900 300

Timing Locking Setting Tool Kit  
Opel 1.3 CDTI Fiat 1.3 D – multi-jet



### 4M-161.1

Brand: Fiat, Alfa, Lancia  
Product Code: 4M-161.1  
OEM Tool Code: 1 870 900 300

Crankshaft locking tool Fiat 1,3  
multi-jet



### 4M-194

Brand: Fiat, Alfa, Lancia  
Product Code: 4M-194

Nut bearing tool Zastava old / new  
type



## 4M-070.7

*Brand:* Fiat, Alfa, Lancia  
*Product Code:* 4M-070.7  
*OEM Tool Code:* MOT-1280

Oil filter replacement tool Alfa  
Romeo TS 87x18



## 4M-904.SA

*Brand:* Fiat, Alfa, Lancia  
*Product Code:* 4M-904.SA  
*OEM Tool Code:* 1 860 985 000 /  
EN-46781 / EN-46785 /  
1 870 900 300 / 1 870 900 300 /  
1 870 896 900 / 200 000 3000

Timing setting tool kit OPEL cdti -  
FIAT multi-jet



## 4M-911.SA

*Brand:* Fiat, Alfa, Lancia  
*Product Code:* 4M-911.SA  
*OEM Tool Code:* 1 860 874 000 /  
1 860 876 001 / 1 860 771 000

Timing setting tool kit FIAT 1.6 16V



## 4M-170

*Brand:* Fiat, Alfa, Lancia  
*Product Code:* 4M-170  
*OEM Tool Code:* EN-6628-A

Camshaft locking tool Opel,  
Chevrolet, Fiat, Alfa Romeo 1,6XER;  
1.8XER



### 4M-170.1

*Brand:* Fiat, Alfa, Lancia  
*Product Code:* 4M-170.1

Variator positioning tool Opel, Chevrolet, Fiat, Alfa Romeo 1,6XER; 1.8XER  
OEM: KM-6340



### 4M-170.2

*Brand:* Fiat, Alfa, Lancia  
*Product Code:* 4M-170.2  
*OEM Tool Code:* KM-6625

Flywheel locking tool Opel, Chevrolet, Fiat, Alfa Romeo 1,6XER; 1.8XER



### 4M-096.12

*Brand:* Fiat, Alfa, Lancia  
*Product Code:* 4M-096.12

Bosch injector pulling tool- Iveco I Ducato 2.3 jtd



### 4M-096.13

*Brand:* Fiat, Alfa, Lancia  
*Product Code:* 4M-096.13

Bosch injector pulling tool- Iveco I Ducato 3.0 jtd



## 4M-034

Brand: Universal tool  
Product Code: 4M-034

Brake cylinder piston repair tool for all types of vehicles



## 4M-071

Brand: Universal tool  
Product Code: 4M-071

Three-thrusters valve spring compression universal tool



## 4M-068

Brand: Universal tool  
Product Code: 4M-068

Steering rack long tie rod end conducting universal tool diameter up to 37 mm



## 4M-069

Brand: Universal tool  
Product Code: 4M-069

Steering rack long tie rod end conducting universal tool diameter up to 42 mm



#### 4M-066

Brand: Universal tool  
Product Code: 4M-066

Universal magnet puller for  
diameter of 15 mm up to 75 mm



#### 4M-083

Brand: Universal tool  
Product Code: 4M-083

Universal clamp/ball separation  
tool for passenger vehicles



#### 4M-084

Brand: Universal tool  
Product Code: 4M-084

Universal clamp/ball separation  
tool for commercial vehicles



#### 4M-033

Brand: Universal tool  
Product Code: 4M-033

Universal clamp/ball, etc.  
separation tool



## 4M-103

Brand: Universal tool  
Product Code: 4M-103

Universal Bosch pump pulley,  
Camshafts, etc., removal tool VW,  
Audi, Seat, Škoda, BMW,  
Mercedes, Peugeot, Fiat, etc.



## 4M-039.1

Brand: Universal tool  
Product Code: 4M-039.1

Rubber valves removal tool  
(5 mm, 6 mm)



## 4M-082

Brand: Universal tool  
Product Code: 4M-082

Clamp separation tool BMW, Audi,  
Mercedes, etc.



## 4M-082.1

Brand: Universal tool  
Product Code: 4M-082.1

Tool for splitting anti-roll bar  
mountings Audi, Ford, BMW,  
Mercedes (202, 210), Opel (24 mm)



### 4M-082.2

*Brand:* Universal tool  
*Product Code:* 4M-082.2

Tool for splitting anti-roll bar mountings Audi A4, A6, A8, VW Passat, Mercedes (203), (28 mm)



### 4M-099

*Brand:* Universal tool  
*Product Code:* 4M-099

Bosch pump, camshaft, etc., support tool VW, Audi, Seat, Škoda, Ford, Fiat, Mercedes, etc.



### 4M-035

*Brand:* Universal tool  
*Product Code:* 4M-035

Clamp separation universal tool



### 4M-035.1

*Brand:* Universal tool  
*Product Code:* 4M-035.1

Clamp separation tool – universal.



## 4M-046

Brand: Universal tool  
Product Code: 4M-046

Wheel removing tool Ford, Opel



## 4M-021.1

Brand: Universal tool  
Product Code: 4M-021.1

Clamp separation universal tool



## 4M-070

Brand: Universal tool  
Product Code: 4M-070

Oil filter replacement tool  
Mercedes, BMW, Audi - VW OK 74



## 4M-091

Brand: Universal tool  
Product Code: 4M-091

Universal shock absorber springs  
removal tool VW, Audi, Seat, Škoda,  
Fiat, etc.





### 4M-032

Brand: Universal tool  
Product Code: 4M-032

Tool for removal and replacement of the front wheel bearing, for VW, Audi, Opel, Fiat, etc.



### 4M-005

Brand: Universal tool  
Product Code: 4M-005

Branches/ drum drive axle/etc. universal removal tool.



### 4M-090

Brand: Universal tool  
Product Code: 4M-090

Shock absorbers cartridge replacement tool Monroe



### 4M-061.2

Brand: Universal tool  
Product Code: 4M-061.2

Nozzle puller tool VM engines - 28 mm



## 4M-074

Brand: Universal tool  
Product Code: 4M-074

Release plunger volume measuring tool



## 4M-031

Brand: Universal tool  
Product Code: 4M-031

Universal Stand for disassembly and reassembly of the engine, the engine block, cylinder head.



## 4M-317

Brand: Universal tool  
Product Code: 4M-317

Wrench for tank floating ring nuts



## 4M-163

Brand: Universal tool  
Product Code: 4M-163

Engine support tool - universal



## 4M-184

Brand: Universal tool  
Product Code: 4M-184

Wiper arm removal tool



## 4M-171

Brand: Universal tool  
Product Code: 4M-171

Hydraulic cylinder 18 t



## 4M-171.2

Brand: Universal tool  
Product Code: 4M-171.2

Hydraulic cylinder 10 t



## 4M-171.4

Brand: Universal tool  
Product Code: 4M-171.4

Hydraulic cylinder 14 t



## 4M-096.3

Brand: Universal tool  
Product Code: 4M-096.3

Injectors extraction tool common rail Universal



## 4M-096.9

Brand: Universal tool  
Product Code: 4M-096.9

Injectors pulling tool-PIAZO



## 4M-096.10

Brand: Universal tool  
Product Code: 4M-096.10

Injectors pulling tool -BOSCH



## 4M-139.2

Brand: Universal tool  
Product Code: 4M-139.2

Dial gauge reduction tool M 10 - long



### 4M-139.3

Brand: Universal tool  
Product Code: 4M-139.3

Dial gauge reduction tool M 10-  
short



### 4M-195

Brand: Universal tool  
Product Code: 4M-195

Cylinder block nozzle removal tool  
– universal



### 4M-307

Brand: Universal tool  
Product Code: 4M-307

Universal weight - 4,5 kg weight



### 4M-307.1

Brand: Universal tool  
Product Code: 4M-307.1

Universal weight - 2,5 kg



## 4M-070.9

Brand: Universal tool  
Product Code: 4M-070.9

Oil filter replacement tool 74x8



## 4M-070.10

Brand: Universal tool  
Product Code: 4M-070.10

Oil filter replacement tool 75x16



## 4M-070.11

Brand: Universal tool  
Product Code: 4M-070.11

Oil filter replacement tool 74x10



## 4M-070.12

Brand: Universal tool  
Product Code: 4M-070.12

Oil filter replacement tool Hyundai  
Santa Fe 79x14



### 4M-070.13

Brand: Universal tool  
Product Code: 4M-070.13

Oil filter replacement tool -  
Hyundai, Kia 78x15



### 4M-070.14

Brand: Universal tool  
Product Code: 4M-070.14

Oil filter removal tool Volvo S60,  
S80, XC90



### 4M-070.16

Brand: Universal tool  
Product Code: 4M-070.16

Fuel filters replacement tool Honda  
Accord 2.0d



### 4M-164

Brand: Universal tool  
Product Code: 4M-164

Studs, bolt, screw extraction tool  
6-12 mm



## 4M-164.1

Brand: Universal tool  
Product Code: 4M-164.1

Studs, bolt, screw loosening tool



## 4M-319

Brand: Universal tool  
Product Code: 4M-319

Common rail fuel volume testing tool



## 4M-400

Brand: Universal tool  
Product Code: 4M-400

Universal magnet puller with additional aid accessories – small



## 4M-331

Brand: Universal tool  
Product Code: 4M-331

Valve guides extraction toolkit





### 4M-069.1

Brand: Universal tool  
Product Code: 4M-069.1

Steering rack extension reeling  
universal tool from 34 to 41 mm



### 4M-069.2

Brand: Universal tool  
Product Code: 4M-069.2

Steering rack extension reeling uni-  
versal tool from 38 to 45 mm



### 4M-905.SA

Brand: Universal tool  
Product Code: 4M-905.SA

Handbrake cylinders on disc  
diameter repair tool VW, Renault,  
Ford, Audi, etc.



### 4M-333 SA

Brand: Universal tool  
Product Code: 4M-333 SA

Overhauling A/C Compressor tool  
kit



## 4M-329

Brand: Universal tool  
Product Code: 4M-329

Camshafts position tool.  
Volvo



## 4M-908.SA

Brand: Universal tool  
Product Code: 4M-908.SA

Clutch replacement universal tool



## 4M-355

Brand: Universal tool  
Product Code: 4M-355

Seal puller tool from 16 mm to  
18 mm



## 4M-355.1

Brand: Universal tool  
Product Code: 4M-355.1

Seal puller tool from 20 mm to  
22 mm



### 4M-355.2

Brand: Universal tool  
Product Code: 4M-355.2

Seal puller tool from 22 mm to 24 mm



### 4M-164.3

Brand: Universal tool  
Product Code: 4M-164.3

Stud removal tool from 6mm to 12 mm



### 4M-091.1

Brand: Universal tool  
Product Code: 4M-091.1

Universal shock absorber springs removal tool VW, Audi, Seat, Škoda, Fiat, etc.



### 4M-117.1

Brand: Universal tool  
Product Code: 4M-117.1

Alternator bearings replacement tool.



## 4M-124

Brand: Trucks  
Product Code: 4M-124

ZF differential nut removal tool



## 4M-128

Brand: Trucks  
Product Code: 4M-128

Crankshaft gear compressor removal tool



## 4M-132

Brand: Trucks  
Product Code: 4M-132

Bosch pump parts removal tool  
ZETOR



## 4M-098

Brand: Trucks  
Product Code: 4M-098

Universal clamp / ball, etc.  
separation tool freight program



### 4M-098.1

Brand: Trucks  
Product Code: 4M-098.1

Universal clamp / ball, etc.  
separation tool freight program  
Mercedes, Volvo, Scania, itd.



### 4M-098.2

Brand: Trucks  
Product Code: 4M-098.2

Universal clamp / ball, etc.  
separation tool freight program  
Mercedes, Volvo, Scania, itd.



### 4M-098.3

Brand: Trucks  
Product Code: 4M-098.3

Universal clamp / ball, etc.  
separation tool freight program  
Mercedes, Volvo, Scania, itd.



### 4M-111

Brand: Trucks  
Product Code: 4M-111

Wheel bearing nut loosening tool  
Iveco, Mercedes, MAN 65 X 12  
angles



## 4M-153

Brand: Trucks  
Product Code: 4M-153

Pre-combustion chamber locking  
ring removal tool, for Mercedes  
1213 - Truck



## 4M-166

Brand: Trucks  
Product Code: 4M-166

Bosch pump repair tool Iveco -  
Rival



## 4M-175

Brand: Trucks  
Product Code: 4M-175  
OEM Tool Code: A-360309

Valve timing tool Iveco



## 4M-192

Brand: Trucks  
Product Code: 4M-192

Differential nut tool R-140 18 teeth



### 4M-070.20

Brand: Trucks  
Product Code: 4M-070.20

Oil filter replacement tool Volvo -  
Truck OK 103 x 15



### 4M-070.21

Brand: Trucks  
Product Code: 4M-070.21

Oil filter replacement tool - Truck OK  
91 X 10



### 4M-070.25

Brand: Trucks  
Product Code: 4M-070.25

Oil filter replacement tool Iveco



### 4M-070.27

Brand: Trucks  
Product Code: 4M-070.27

Drier removal tool for freight  
vehicles



## 4M-200.45

Brand: Trucks

Product Code: 4M-200.45

OEM Tool Code: 99360615-C.F.4458

Crankshaft locking tool Fiat Ducato

2.3 JTD Iveco 3.0



## 4M-200.46

Brand: Trucks

Product Code: 4M-200.46

OEM Tool Code: 99360614-C.F.4458

Camshaft locking tool Fiat Ducato

2.3 JTD Iveco 3.0



## 4M-321

Brand: Trucks

Product Code: 4M-321

Lower balls removal toll IVECO



## 4M-321.1

Brand: Trucks

Product Code: 4M-321.1

Lower balls removal toll IVECO





## 4M-125

Brand: Trucks  
Product Code: 4M-125

Rear Axle Drive Flange removal  
tool, for Mercedes Sprinter, VW - LT



## 4M-125.1

Brand: Trucks  
Product Code: 4M-125.1

Rear Axle Drive Flange removal  
tool, Mercedes-Sprinter 616 -  
double wheels



## 4M-316

Brand: Trucks  
Product Code: 4M-316  
OEM Tool Code: 80.99601.0205  
0304

Pump removal tool Mercedes, MAN  
-Truck



## 4M-318

Brand: Trucks  
Product Code: 4M-318

Transmission nuts removal tool  
Scania



## 4M-G105.08

Brand: Trucks  
Product Code: 4M-G105.08

Socket wrench 105mm x 8 point



## 4M-G105.12

Brand: Trucks  
Product Code: 4M-G105.12

Socket wrench 105mm x 8 - IVECO  
- Stralis, Major, Cursor



## 4M-322

Brand: Trucks  
Product Code: 4M-322

Front Wheel bolt loosening tool  
MAN-TG



## 4M-351

Brand: Trucks  
Product Code: 4M-351

Wheel removal tool for trucks  
/freight vehicles (large)



## 4M-351.1

Brand: Trucks  
Product Code: 4M-351.1

Wheel removal tool for trucks and  
freight trucks (short)



## 4M-402

Brand: Trucks  
Product Code: 4M-402

Drum puller tool for freight vehicles



## 4M-354

Brand: Trucks  
Product Code: 4M-354

Silent block nut removal tool  
SETRA- Buses /freight vehicles



## 4M-356

Brand: Trucks  
Product Code: 4M-356

Mainshaft nut removal tool  
COBRA- Buses /freight vehicles



## 4M-357

Brand: Trucks  
Product Code: 4M-357

Flange removal tool Mercedes  
Conecto-Freight vehicles



## 4M-096.12

Brand: Trucks  
Product Code: 4M-096.12

Injectors pulling tool- Iveco I  
Ducato 2.3 jtd



## 4M-096.13

Brand: Trucks  
Product Code: 4M-096.13

Injectors pulling tool- Iveco I  
Ducato 3.0 jtd



## 4M-G46x12

Brand: Trucks  
Product Code: 4M-G46x12

Socket wrench 46mm x 12 point



### 4M-G56.12

Brand: Trucks  
Product Code: 4M-G56.12

Socket wrench 56mm x 12 point



### 4M-G80.08

Brand: Trucks  
Product Code: 4M-G80.08

Socket wrench 80mm x 8 point



### 4M-G80.12

Brand: Trucks  
Product Code: 4M-G80.12

Socket wrench 80mm x 12 point



### 4M-G85.6

Brand: Trucks  
Product Code: 4M-G85.6

Socket wrench 85mm x 6 point



## 4M-G90.6

Brand: Trucks  
Product Code: 4M-G90.6

Socket wrench 90mm x 6 point



## 4M-G95.06

Brand: Trucks  
Product Code: 4M-G95.06

Socket wrench 95mm x 6 point



## 4M-G114.12

Brand: Trucks  
Product Code: 4M-G114.12

Socket wrench 114mm x 12 point



## 4M-G120.08

Brand: Trucks  
Product Code: 4M-G120.08

Socket wrench 120mm x 8 point



**4M** AUTOMOTIVE  
SPECIALTY TOOLS

[www.4mtools.com](http://www.4mtools.com)